

ENGLISH

Canon

PowerShot A540

PowerShot A530

DIGITAL CAMERA



Photo of PowerShot A540

Before Using the Camera

Shooting

Playback/Erasing

Print/Transfer Settings

Viewing Images on a TV set

Troubleshooting

List of Messages

Appendix

Advanced

Camera User Guide

This guide explains camera features and procedures in detail.

DiGiC II



Exif Print



Main Features

Shooting

- Automatically adjusts shooting settings to match particular conditions
- Avoid the effects of camera shake or blurry subjects when shooting by using a high ISO speed
- Automatically detects camera orientation with an Intelligent Orientation sensor
- Changes specific image colors to shoot (Color Accent, Color Swap)
- Attaches the separately sold wide converter, tele-converter or close-up lens to shoot (PowerShot A540 only)

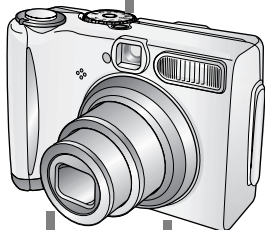

Playback

- Plays movies with sound
- Plays back automatically using the Auto Play function

Editing

- Records sound memos for still images
- Edits movies

Printing

- Makes printing easy with the Print/Share button
- Also supports non-Canon brand *PictBridge* compliant printers

Uses of Recorded Images

- Effortlessly transfer them to a computer with the Print/Share button

In this guide, explanations are given using illustrations for PowerShot A540.

Conventions Used in this Guide

Icons appearing below titles indicate the shooting modes in which the procedure can be used.

Mode switch

Continuous Shooting



PowerShot A540

PowerShot A530

* Unavailable shooting modes are shown grayed out.

See *Functions Available in Each Shooting Mode* (p. 135).

- In this guide, the *Basic Camera User Guide* is referred to as the *Basic Guide*, and the *Advanced Camera User Guide* is referred to as the *Advanced Guide*.



This mark denotes issues that may affect the camera's operation.



This mark denotes additional topics that complement the basic operating procedures.

You can use SD* memory cards and MultiMediaCards with this camera. These cards are collectively called memory cards in this guide.

* SD stands for Secure Digital, a copyright protection system.





Use of genuine Canon accessories is recommended.

This product is designed to achieve excellent performance when used with genuine Canon accessories. Canon shall not be liable for any damage to this product and/or accidents such as fire, etc., caused by the malfunction of non-genuine Canon accessories (e.g., a leakage and/or explosion of a battery pack). Please note that this warranty does not apply to repairs arising out of the malfunction of non-genuine Canon accessories, although you may request such repairs on a chargeable basis.

Table of Contents

Items marked with a ★ are lists or charts that summarize camera functions or procedures.

| | |
|--|-----------|
| Handling Precautions | 5 |
| Please Read | 5 |
| Safety Precautions | 6 |
| Preventing Malfunctions | 11 |
| Before Using the Camera – The Components Guide ... | 12 |
| Before Using the Camera – Basic Operations | 15 |
| Using the LCD Monitor | 15 |
| Information Displayed on the LCD Monitor | 16 |
| Using the Viewfinder | 19 |
| Indicators | 20 |
| Power Saving Function | 21 |
| ★ Menus and Settings | 22 |
| ★ Menu List | 24 |
| Resetting Settings to Their Default Values | 29 |
| Formatting Memory Cards | 30 |
| Shooting | 31 |
| Changing the Recording Pixels and Compression (Still Images) | 31 |
| Using the Digital Zoom | 33 |
| Continuous Shooting | 34 |
| Postcard Date Imprint Mode | 35 |
| Using the Self-Timer | 37 |
| 🎬 Movie Shooting | 39 |
| 📷 Shooting Panoramic Images (Stitch Assist) | 43 |
| P Program AE | 44 |
| Tv Setting the Shutter Speed | 45 |
| Av Setting the Aperture | 46 |
| M Manually Setting the Shutter Speed and Aperture | 47 |
| Selecting an AF Frame | 49 |
| Shooting Hard-to-Focus Subjects (Focus Lock, AF Lock, Manual Focus) | 50 |
| Switching between Metering Modes | 53 |

| | |
|---|-----------|
|  Adjusting the Exposure Compensation | 54 |
| Adjusting the Tone (White Balance) | 55 |
| Shooting in a My Colors Mode | 58 |
| Changing the Color | 60 |
| Adjusting the ISO Speed | 65 |
| Switching between Flash Adjustment Settings | 65 |
| Compensating the Flash Adjustment / Flash Output | 66 |
| Setting the Auto Rotate Function | 67 |
| Creating an Image Destination (Folder) | 68 |
| Resetting the File Number | 70 |
| Playback/Erasing | 72 |
|  Magnifying Images | 72 |
|  Viewing Images in Sets of Nine (Index Playback) | 73 |
|  Jumping to Images | 74 |
| Viewing Movies | 75 |
| Editing Movies | 76 |
| Rotating Images in the Display | 78 |
| Attaching Sound Memos to Images | 79 |
| Automated Playback (Auto Play) | 80 |
| Protecting Images | 81 |
| Erasing All Images | 82 |
| Print Settings/Transfer Settings | 83 |
| Setting the DPOF Print Settings | 83 |
| Setting the DPOF Transfer Settings | 86 |
| Viewing Images on a TV set | 88 |
| Troubleshooting | 89 |
| Camera | 89 |
| When the power is turned on | 89 |
| LCD monitor | 90 |
| Shooting | 91 |
| Shooting Movies | 95 |
| Playback | 96 |
| Battery | 97 |
| TV monitor output | 97 |
| Printing with a direct print compatible printer | 98 |

| | |
|--|------------|
| List of Messages | 99 |
| Appendix | 102 |
| Battery Handling | 102 |
| Handling the Memory Card | 104 |
| Using the Power Kits (Sold Separately) | 106 |
| Using the Lenses (Sold Separately) (PowerShot A540 only) | 109 |
| Using an Externally Mounted Flash (Sold Separately) | 112 |
| Replacing the Date Battery | 114 |
| Camera Care and Maintenance | 116 |
| Specifications | 117 |
| INDEX | 131 |
| ★ Functions Available in Each Shooting Mode | 135 |

Handling Precautions

Please Read

Test Shots

Before you try to photograph important subjects, we highly recommend that you shoot several trial images to confirm that the camera is operating and being operated correctly.

Please note that Canon Inc., its subsidiaries and affiliates, and its distributors are not liable for any consequential damages arising from any malfunction of a camera or accessory, including memory cards, that results in the failure of an image to be recorded or to be recorded in a way that is machine readable.

Warning Against Copyright Infringement

Please note that Canon digital cameras are intended for personal use and should never be used in a manner that infringes upon or contravenes international or domestic copyright laws and regulations. Please be advised that in certain cases the copying of images from performances, exhibitions, or commercial properties by means of a camera or other device may contravene copyright or other legal rights even if the image was shot for personal use.

Warranty Limitations

For information on your camera's warranty, please refer to the Canon European Warranty System (EWS) Booklet supplied with your camera.

For Canon Customer Support contacts, please see the European Warranty System (EWS) Booklet.

Camera Body Temperature

If your camera is used for prolonged periods, the camera body may become warm. Please be aware of this and take care when operating the camera for an extended period.

About the LCD Monitor

The LCD monitor is produced with extremely high-precision manufacturing techniques. More than 99.99% of the pixels operate to specification. Less than 0.01% of the pixels may occasionally misfire or appear as red or black dots. This has no effect on the recorded image and does not constitute a malfunction.

Video Format

Please set the camera's video signal format to the one used in your region before using it with a TV monitor (p. 88).

Language Setting

Please see the *Basic Guide* (p. 3) to change the language setting.

Safety Precautions

- Before using the camera, please ensure that you read the safety precautions described below and in the "Safety Precautions" section of the *Basic Camera User Guide*. Always ensure that the camera is operated correctly.
- The safety precautions noted on the following pages are intended to instruct you in the safe and correct operation of the camera and its accessories to prevent injuries or damage to yourself, other persons and equipment.
- Equipment refers to the camera, battery, battery charger (sold separately) and compact power adapter (sold separately).

Warnings

Equipment

- **Do not look directly into the sun or at bright light sources through the camera's viewfinder.**

Doing so can damage your eyesight.

- **Store this equipment out of the reach of children and infants. Accidental damage by a child could result in serious injury.**
 - Wrist strap: Placement of the strap around the child's neck could result in asphyxiation.
 - Memory card: It may be swallowed accidentally. If this occurs, contact a doctor immediately.

- **Do not attempt to disassemble or alter any part of the equipment that is not expressly described in this guide.**
- **To avoid the risk of high-voltage electrical shock, do not touch the flash portion of the camera if it has been damaged.**
- **Stop operating the equipment immediately if it emits smoke or noxious fumes.**
- **Do not allow the equipment to come into contact with, or become immersed in, water or other liquids. If the exterior comes into contact with liquids or salt air, wipe it dry with a soft, absorbent cloth.**

Continued use of the equipment may result in fire or electrical shock. Immediately turn the camera power off and remove the camera batteries or unplug the power cord from the power outlet. Please consult your camera distributor or the closest Canon Customer Support Help Desk.

- **Do not use substances containing alcohol, benzene, thinners or other flammable substances to clean or maintain the equipment.**
- **Do not cut, damage, alter or place heavy items on the power cord.**
- **Use only recommended power accessories.**
- **Remove the power cord on a regular periodic basis and wipe away the dust and dirt that collects on the plug, the exterior of the power outlet and the surrounding area.**
- **Do not handle the power cord if your hands are wet.**

Continued use of the equipment may result in fire or electrical shock.

Battery

- Do not place the batteries near a heat source or expose it to direct flame or heat.
- The batteries should not be immersed in water or sea water.
- Do not attempt to disassemble, alter or apply heat to the batteries.
- Avoid dropping or subjecting the batteries to severe impacts that could damage the casing.
- Use only recommended batteries and accessories.

Use of batteries not expressly recommended for this equipment may cause explosions or leaks, resulting in fire, injury and damage to the surroundings. In the event that a battery leaks and the eyes, mouth, skin or clothing contact these substances, immediately flush with water and seek medical assistance.

- Disconnect the battery charger and compact power adapter from both the camera and the power outlet after recharging or when not in use to avoid fire and other hazards.
- Do not place anything, such as tablecloths, carpets, bedding or cushions, on top of the battery charger while it is charging.

Continued use over a long period may cause the units to overheat and distort, resulting in fire.

- When recharging the Canon AA-size NiMH batteries, use only a specified battery charger.
- The compact power adapter is designed for exclusive use with this equipment. Do not use it with other products.

There is a risk of overheating and distortion which could result in fire or electrical shock.

- Before you discard a battery, cover the terminals with tape or other insulators to prevent direct contact with other objects.

Contact with the metallic components of other materials in waste containers may lead to fire or explosions.

Others

- **Do not trigger the flash in close proximity to human or animal eyes. Exposure to the intense light produced by the flash may damage eyesight.**

In particular, remain at least one meter (39 inches) away from infants when using the flash.

- **Keep objects that are sensitive to magnetic fields (such as credit cards) away from the speaker of the camera.**

Such items may lose data or stop working.

- **Exercise due caution when screwing on the separately sold wide converter, tele-converter, close-up lens and conversion lens adapter. (PowerShot A540 only)**

If they loosen, fall off and shatter, the glass shards may cause injury.

Cautions

Equipment

- **Be careful not to bang the camera or subject it to strong impacts or shocks that could lead to injury or damage the equipment when wearing or holding it by the strap.**
- **Do not store the equipment in humid or dusty areas.**
- **Do not allow metal objects (such as pins or keys) or dirt to contact the charger terminals or plug.**

Such conditions could lead to fire, electrical shock or other damage.

- **Avoid using, placing or storing the equipment in places subject to strong sunlight or high temperatures, such as the dashboard or trunk (boot) of a car.**
- **Do not use the equipment in a manner that exceeds the rated capacity of the electrical outlet or wiring accessories. Do not use if the power cord or plug is damaged, or if not fully plugged into the outlet.**
- **Do not use in locations with poor ventilation.**

The above-mentioned can cause leakage, overheating or explosion, resulting in fire, burns or other injuries. High temperatures may also cause deformation of the casing.

Equipment

- **When not using the camera for extended periods of time, remove the batteries from the camera or battery charger and store the equipment in a safe place.**

If the batteries are left inside the camera, damage caused by leakage may occur.

- **Do not connect compact power adapters or battery chargers to devices such as electrical transformers for foreign travel because it may lead to malfunctions, excessive heat generation, fire, electric shock or injury.**

Flash

- **Do not operate the flash with dirt, dust or other items stuck to the surface of the flash.**
- **Be careful not to cover the flash with your fingers or clothing when shooting.**

The flash may be damaged and emit smoke or noise. The resulting heat build-up could damage the flash.

- **Do not touch the surface of the flash after taking several pictures in rapid succession.**

Doing so could result in burns.

Preventing Malfunctions

Avoid Strong Magnetic Fields

- **Never place the camera in close proximity to electric motors or other equipment generating strong electromagnetic fields.**

Exposure to strong magnetic fields may cause malfunctions or corrupt image data.

Avoid Condensation Related Problems

- **When moving the equipment rapidly between hot and cold temperatures, you can avoid condensation by placing the equipment in an airtight, resealable plastic bag and letting it adjust to temperature changes slowly before removing it from the bag.**

Moving the equipment rapidly between hot and cold temperatures may cause condensation (water droplets) to form on its external and internal surfaces.

If Condensation Forms Inside the Camera

- **Stop using the camera immediately.**

Continued use may damage the equipment. Remove the memory card and batteries or compact power adapter from the camera and wait until the moisture evaporates completely before resuming use.

Front View

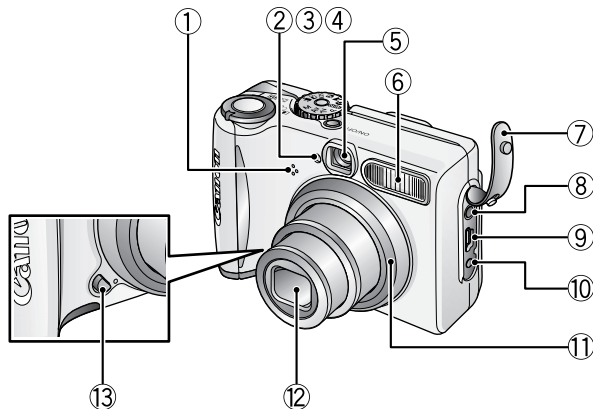

- ① Microphone (p. 79)
- ② AF-assist Beam (p. 24)
- ③ Red-Eye Reduction Lamp (*Basic Guide* p. 8)
- ④ Self-Timer Lamp (p. 37)
- ⑤ Viewfinder Window (p. 19)
- ⑥ Flash (*Basic Guide* p. 8)
- ⑦ Terminal Cover
- ⑧ A/V OUT (Audio/Video output) Terminal (p. 88)
- ⑨ DIGITAL Terminal (*Basic Guide* p. 19)
- ⑩ DC IN Terminal (Power input) (p. 108)
- ⑪ Ring*
- ⑫ Lens
- ⑬ Ring Release Button*

* PowerShot A540 only

Back View

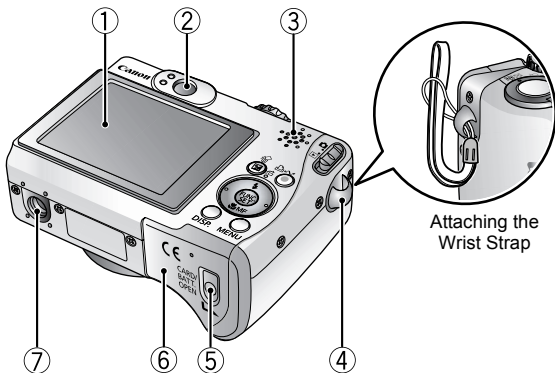

- ① LCD Monitor (p. 15)
- ② Viewfinder (p. 19)
- ③ Speaker
- ④ Wrist Strap Mount
- ⑤ Memory Card Slot / Battery Cover Lock (*Basic Guide* p. 1)
- ⑥ Memory Card Slot / Battery Cover (*Basic Guide* p. 1)
- ⑦ Tripod Socket

Operation Panel

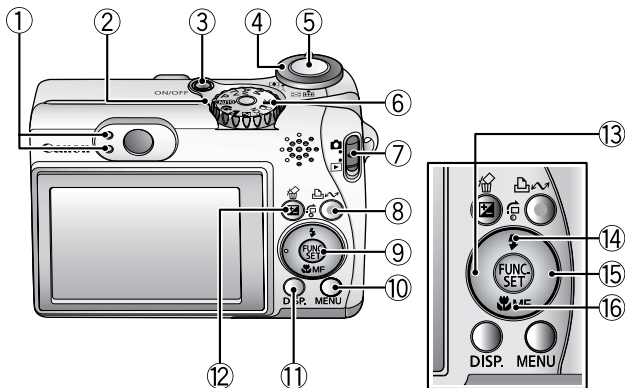

- ① Indicators (p. 20)
- ② Power Lamp
- ③ Power Button (*Basic Guide* p. 4)
- ④ Zoom Lever (p. 72, *Basic Guide* p. 8)
Shooting: (Wide Angle)/ (Telephoto)
Playback: (Index)/ (Magnify)
- ⑤ Shutter Button (*Basic Guide* p. 4)
- ⑥ Shooting Mode Dial (*Basic Guide* p. 5)
- ⑦ Mode Switch (*Basic Guide* p. 4, 11)
- ⑧ (Print/Share) Button (*Basic Guide* p. 14)
- ⑨ **FUNC./SET** (Function/Set) Button (p. 22)
- ⑩ **MENU** Button (p. 23)
- ⑪ **DISP.** (Display) Button (p. 15)
- ⑫ (Exposure)/ (Single Image Erase) Button
(p. 54, *Basic Guide* p. 11)
- ⑬ Button
- ⑭ (Flash)/ (Jump)/ Button (p. 74, *Basic Guide* p. 8)
- ⑮ Button
- ⑯ (Macro)/ **MF** (Manual Focus)/ Button
(p. 51, *Basic Guide* p. 10)

Using the LCD Monitor

1 Press .

- The display mode changes as follows with each press.

Shooting Mode ()

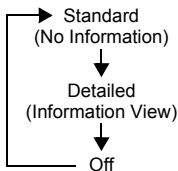



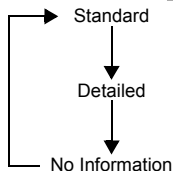

Playback Mode ()



- In the shooting mode, the shooting information displays for approximately 6 sec. when a setting is changed, regardless of the selected display mode.



- The LCD monitor on or off setting is retained even after the camera power is turned off.
- The LCD monitor does not shut off in the , SCN ( , ) or  mode.
- The LCD monitor will not switch to the detailed display in the index playback mode (p. 73).

Night Display

When shooting in dark conditions, the camera automatically brightens the LCD monitor to suit the brightness of the subject*, making it easier to frame the subject.

* The movements of the subject will appear irregular in the LCD monitor. The recorded image will not be affected. The brightness of the image displayed in the monitor, and the brightness of the actual image recorded will be different.

Information Displayed on the LCD Monitor

Shooting Information (Shooting Mode)

[]*1 Spot AE Point Frame (p. 53) □*1 AF Frame (p. 49)

*1 Low Battery (p. 102)

Zoom Magnification*1 (p. 33)

Grid Lines*1
(p. 25)

ISO 80 ISO 100 ISO 200 ISO 400 ISO 800 ISO Speed (p. 65)

White Balance (p. 55)

Drive Mode (p. 34, 37)

My Colors (p. 58)

Flash Exposure Compensation/
Flash Output (p. 66)

Metering Mode (p. 53)

Recording Pixels (p. 32, 42)

Compression
(Still image) (p. 32)

Frame Rate (Movies)*2 (p. 42)

Flash (Basic Guide p. 8)

Red-Eye Reduction
(Basic Guide p. 8)

Auto Rotate (p. 67)

Rec*1 Movie Recording (p. 39)

Shooting Mode

(Basic Guide p. 5–7)

(p. 43)

*1 *1 *2 *1 *1 *1 (p. 39)

*2 *2 *2 (p. 44 – 47)

*1 Create Folder (p. 68)

- Stills: Recordable Shots
- Movies: Remaining Time/
Elapsed Time

Shutter Speed*1 (p. 45, 47)

Aperture Value*1 (p. 46, 47)

-2 ... +2*1
Exposure Compensation (p. 54)

*1 Macro (Basic Guide p. 10)

MF*1 Manual Focus (p. 51)

MF*1 AF Lock (p. 50)



(Red)*1 Camera Shake
Warning (p. 17)

For PowerShot A530, when is displayed, the shutter speed will also display.

*1 Appears even if the LCD monitor is set to Standard display.

*2 PowerShot A540 only



If the indicator blinks orange and the camera shake warning icon  displays, this indicates that a slow shutter speed may have been selected due to insufficient illumination. Raise the ISO speed (p. 65) or select a setting other than  (flash off), or attach the camera to a tripod or other device.

Playback Information (Playback Mode)

■ Standard

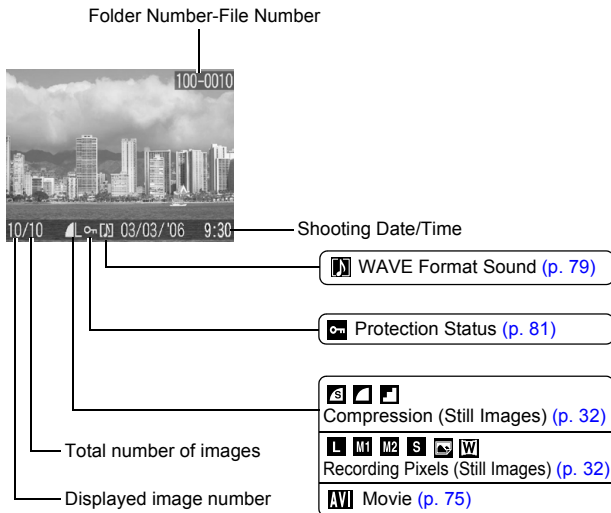

■ Detailed



Histogram

| | |
|---|---|
| <p>Recording Pixels/Frame Rate (Movies) (p. 42)</p> <p>Movie Length (Movies) (p. 39)</p> | <p>Exposure Compensation (p. 54)</p> |
| <p>Shutter Speed (p. 45, 47)</p> | <p>White Balance (p. 55)</p> |
| <p>Aperture Value (p. 46, 47)</p> | <p>My Colors (p. 58)</p> |
| <p>Flash Output (p. 66)</p> | <p>ISO Speed (p. 65)</p> |
| <p>Flash Exposure Compensation (p. 66)</p> | <p>Manual Focus (p. 51)</p> |
| <p>Shooting Mode</p> <p>(Basic Guide p. 5 – 7)</p> <p>(p. 43) (p. 39)</p> <p>P Tv *1 Av *1 M (p. 44 – 47)</p> | <p>Macro (Basic Guide p. 10)</p> |
| | <p>Metering Mode (p. 53)</p> |
| | <p>Recording Pixels (Still Image) (p. 32)</p> |

*1 PowerShot A540 only

*2 PowerShot A530 only

*3 Appears with images taken in the Color Accent or Color Swap shooting modes.

The following information may also be displayed with some images.

| | |
|--|---|
| | A sound file in a format other than the WAVE format is attached or the file format is not recognized. |
| | JPEG image not conforming to Design rule for Camera File System Standards (p. 119) |
| | RAW image |
| | Unrecognized data type |



Information for images shot on other cameras may not display correctly.

Histogram Function

The histogram is a graph that allows you to judge the brightness of the image. The greater the bias toward the left in the graph, the darker the image. The greater the bias toward the right, the brighter the image.

If the image is too dark, adjust the exposure compensation to a positive value. Similarly, adjust the exposure compensation to a negative value if the image is too bright (p. 54).

Sample Histograms



Dark Image



Balanced Image

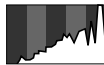

Bright Image

Using the Viewfinder

The viewfinder can be used to conserve power by turning the LCD monitor off (p. 15) while shooting.

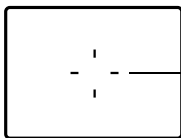

Shows the center of the image

Viewfinder

Indicators

The camera indicators will light or blink under the following conditions.



Never do the following while the green indicator blinks.

These actions may corrupt image data.

- Shake or jolt the camera
- Shut off the power, or open the memory card slot/battery cover

● Upper Indicator

Green: Ready to shoot

Blinking Green: Image recording/reading/erasing/transferring (when connected to a computer)

Orange: Ready to shoot (flash on)

Blinking Orange: Ready to shoot (camera shake warning), charging flash

● Lower Indicator

Yellow: Macro mode/Manual focus mode/AF lock mode

Blinking Yellow: Focusing difficulty (camera beeps once)

Power Saving Function

This camera is equipped with a power saving function. The power will shut off in the following circumstances. Press the power button again to restore power.

| | |
|---|--|
| Shooting Mode | Powers down approximately 3 minutes after the last control is accessed on the camera. The LCD monitor automatically turns off 1 minute* after the last control is accessed even if [Auto Power Down] is set to [Off]. Press any button other than the power button or change the camera orientation to turn the LCD monitor back on. |
| Playback Mode Connected to a Printer | Powers down approximately 5 minutes after the last control is accessed on the camera. |

* This time can be changed.



- The power saving function will not activate during an Auto Play or while the camera is connected to a computer.
- The power saving function settings can be changed (p. 26).

Menus and Settings

Menus are used to set the shooting, playback and print settings as well as such camera settings as the date/time and electronic beep. The following menus are available.

● FUNC. Menu

● Rec., Play, Print, Set up and My Camera Menus

FUNC. Menu

Sets many of the functions commonly used during shooting.

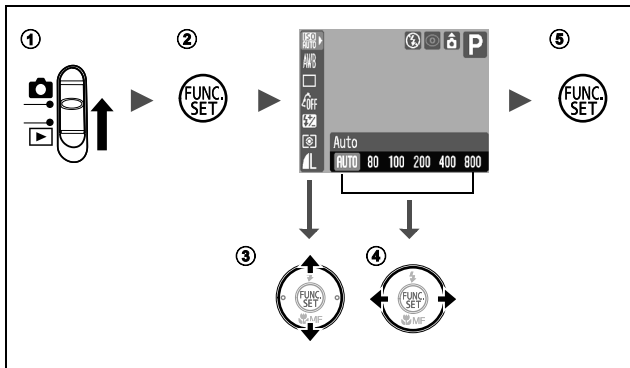

① Set the mode switch to (shooting).

② Press the FUNC./SET button.

③ Use the or button to select a menu item.

- Some items may not be selectable in some shooting modes.

④ Use the or button to select an option for the menu item.

- You can select further options with the **MENU** button for some options.
- After selecting an option, you can press the shutter button to shoot immediately. After shooting, this menu will appear again, allowing you to adjust the settings easily.

⑤ Press the FUNC./SET button.

Rec., Play, Print, Set up and My Camera Menus

Convenient settings for shooting, playback or printing can be set with these menus.

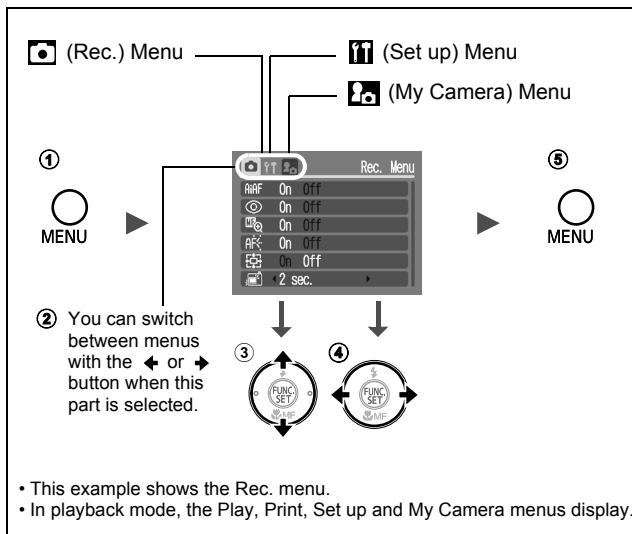









- ① Press the MENU button.
- ② Use the ← or → button to switch between menus.
 - You can also use the zoom lever to switch between menus.
- ③ Use the ↑ or ↓ button to select a menu item.
 - Some items may not be selectable in some shooting modes.
- ④ Use the ← or → button to select an option.
 - Menu items followed by an ellipsis (...) can only be set after pressing the FUNC./SET button to display the next menu. Press the FUNC./SET button again to confirm the setting.
- ⑤ Press the MENU button.

Menu List









FUNC. Menu



The icons shown below are the default settings.

| Menu Item | Reference Page | Menu Item | Reference Page |
|--|----------------|---|----------------|
|  ISO Speed | p. 65 |  Metering Mode | p. 53 |
|  White Balance | p. 55 |  Compression (still image) Recording Pixels (still image) | p. 32 |
|  Drive Mode | p. 34, 37 | PowerShot A540 : | p. 42 |
|  My Colors | p. 58 |  Recording Pixels/ Frame Rate (movie) | |
|  +/- (Flash)/ Flash Output | p. 66 | PowerShot A530:  Recording Pixels (movie) | |







Rec. Menu

*Default setting

| Menu Item | Options | Reference Page |
|--|--|-------------------------|
|  AiAF | On*/Off | p. 49 |
|  Flash Adjust (PowerShot A540 only) | Auto*/Manual | p. 65 |
|  Red-Eye | On*/Off | <i>Basic Guide</i> p. 8 |
|  MF-Point Zoom | On*/Off | p. 51 |
|  AF-assist Beam | On*/Off | — |
|  Digital Zoom | On/Off* ([On] in standard movie mode) | p. 33 |
|  Review | Off/2*–10 seconds/Hold | <i>Basic Guide</i> p. 5 |
|  Save Original | On/Off* | p. 64 |

| Menu Item | Options | Reference Page |
|--|-----------------------|---|
|  Grid Lines | On/Off* | You can display grid lines (split into nine) to make it easier to judge the horizontal and vertical alignment of a photographic subject and to make composition easier. The lines will not be recorded in the images. |
|  Date Stamp | Off*/Date/Date & Time | p. 36 |

Play Menu













| Menu Item | Reference Page |
|--|-----------------------|
|  Auto Play | p. 80 |
|  Sound Memo | p. 79 |
|  Protect | p. 81 |
|  Rotate | p. 78 |
|  Erase all | p. 82 |
|  Transfer Order | p. 86 |











Print Menu



| Menu Item | Reference Page |
|----------------------|-----------------------|
| Print | p. 83 |
| Select Image & Qty. | |
| Select All Images | |
| Clear All Selections | |
| Print Settings | |

Set up Menu

*Default setting

| Menu Item | Options | Reference Page |
|---|---|--|
|  Mute | On/Off* | Set to [On] to silence all operation sounds except for the warning sounds (<i>Basic Guide</i> p. 4). |
|  Volume | Off/1/2*/3/4/5 | Adjusts the volume of the start-up sound, operation sound, self-timer sound, shutter sound and playback sound. The volume cannot be adjusted if [Mute] is set to [On]. |
|  Start-up Vol. | | Adjusts the volume of the start-up sound when the camera is turned on. |
|  Operation Vol. | | Adjusts the volume of the operation sound that beeps when any button other than the shutter button is pressed. |
|  Selftimer Vol. | | Adjusts the volume of the self-timer sound played 2 sec. before the shutter is released. |
|  Shutter Volume | | Adjusts the volume of the sound played when the shutter releases. The shutter sound does not play when a movie is recording. |
|  Playback Vol. | | Adjusts the volume of movie sounds and sound memos. |
|  Power Saving | | p. 21 |
|  Auto Power Down | On*/Off | Sets whether or not the camera automatically powers down after a set period of time elapses without the camera being operated. |
|  Display Off | 10 sec./20 sec./ 30 sec./1 min.*/ 2 min./3 min. | Sets the length of time before the LCD monitor turns off when no camera operation is performed. |
|  Date/Time | | <i>Basic Guide</i> p. 3 |
|  Format | | p. 30 |





| Menu Item | Options | Reference Page |
|--|--|---|
|  File Numbering | Continuous*/ Auto Reset | p. 70 |
|  Create Folder | | |
| Create New Folder | Check mark (On)/ No check mark (Off) | Creates a folder during the next shooting session. |
| Auto Create | Off*/Daily/ Monday-Sunday/ Monthly | You can also set a creation time. |
|  Auto Rotate | On*/Off | p. 67 |
|  Distance Units | m/cm* / ft/in | Sets the units for the MF indicator distance unit (p. 51). |
|  Lens Retract | 1 minute*/ 0 seconds | Sets the lens retraction timing when switching from shooting mode to playback mode. |
|  Language | | <i>Basic Guide</i> p. 3 |
|  Video System | NTSC*/ PAL | p. 88 |
|  Print Method | Auto*/  | See below* ¹ . |
|  Reset All | | p. 29 |

*1 The connection method with the printer can be changed. Although it is normally not necessary to change the setting, select  when borderless printing an image shot in  (Widescreen) mode on wide size paper using Canon compact photo printer SELPHY CP710/CP510. As this setting will be stored to memory even when the power is turned off, to print using an image size other than , return the mode to [Auto].

My Camera Menu

The camera's start-up image and start-up sound, operation sounds, self-timer sounds, and shutter sounds are called "My Camera settings". You can also use the supplied software to upload your computer's images and sounds to the camera.

*Default setting

| Menu Item | Options |
|--|--|
|  Start-up Image | When the power is turned on, the start-up image appears. |
|  Start-up Sound | When the power is turned on, a start-up sound is played. |
|  Operation Sound | When a button other than the shutter button is pressed, an operation sound will be played. |
|  Selftimer Sound | While shooting in self-timer mode, a sound will be played two seconds before the shutter releases. |
|  Shutter Sound | A sound will be played when the shutter button is fully pressed. |
| Settings | On*/Off |



- See the supplied *Software Starter Guide* for more information on creating and adding to the My Camera settings.
- A computer is required to restore the My Camera settings to the defaults. Use the supplied software (ZoomBrowser EX/ImageBrowser) to restore the default settings to the camera.

1 (Set up) Menu [Reset All].

See *Menus and Settings* (p. 23).



2 Select [OK] and press .



- Settings cannot be reset when the camera is connected to a computer or to a printer.
- The following cannot be reset.
 - Shooting mode
 - The [Date/Time], [Language] and [Video System] options in the  (Set up) menu (p. 26, 27)
 - White balance data recorded with the custom white balance function (p. 56)
 - Colors specified in the [Color Accent] (p. 61) or [Color Swap] (p. 62) modes

Formatting Memory Cards



You should always format a new memory card or one from which you wish to erase all images and other data.



Please note that formatting (initializing) a memory card erases all data, including protected images and other file types.

1 (Set up) Menu [Format].

See Menus and Settings (p. 23).

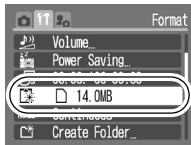

2 Select [OK] and press .

- To perform a low level format, use the button to select [Low Level Format] and the or button to add a check mark.
- You can stop formatting a card when [Low Level Format] is selected by pressing the **FUNC./SET** button. You can still use a card without problem when formatting is halted, but its data will be erased.

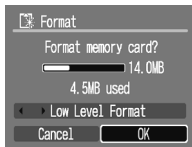

Low Level Format

We recommend you select [Low Level Format] when you think that the recording/reading speed of a memory card has dropped. A low level format may require 2 to 3 minutes with some memory cards.

Changing the Recording Pixels and Compression (Still Images)

PowerShot A540

      **P** Tv Av M

PowerShot A530

      **P** M

1 **FUNC. Menu** * **(Recording Pixels)** **(Compression).**

See Menus and Settings (p. 22).

* Default setting.



- Use the  or  button to select recording pixel/compression settings and press the **FUNC./SET** button.



Approximate Values for Recording Pixels

| Recording Pixels | | | Purpose |
|---|--------------------|--------------------|--|
| | PowerShot A540 | PowerShot A530 | |
| L (Large) | 2816 x 2112 pixels | 2592 x 1944 pixels | High ↑ (PowerShot A540) Printing to about A3 size (Approx. 297 x 420 mm (11.7 x 16.5 in.)) |
| | | | (PowerShot A530) Printing to about A4 size (Approx. 210 x 297 mm (8.3 x 11.7 in.)) |
| M1 (Medium 1) | 2272 x 1704 pixels | 2048 x 1536 pixels | (PowerShot A540) Printing to about A4 size (Approx. 210 x 297 mm (8.3 x 11.7 in.)) |
| | | | (PowerShot A530) Printing to about A5 size (Approx. 149 x 210 mm (5.9 x 8.3 in.)) |
| M2 (Medium 2) | 1600 x 1200 pixels | | Print postcard-size prints 148 x 100 mm (6 x 4 in.) Print L-size prints 119 x 89 mm (4.7 x 3.5 in.) |
| S (Small) | 640 x 480 pixels | | Send images as e-mail attachments or shoot more images |
|  (Postcard Date Imprint Mode) | 1600 x 1200 pixels | | When printing to postcards (p. 35) |
| W (Wide- screen) | 2816 x 1584 pixels | 2592 x 1456 pixels | Print on wide paper (Records at a 16:9 width-to-height aspect ratio. Portions not recorded are left black.) |

Approximate Values for Compression Settings

| Compression | | Purpose |
|--|------------------------------|-----------------------------|
|  Superfine | High Quality ↑↓ Normal | Shoot higher quality images |
|  Fine | | Shoot normal quality images |
|  Normal | | Shoot more images |



- See *Image Data Sizes (Estimated)* (p. 126).
- See *Memory Cards and Estimated Capacities* (p. 123, 124).

Using the Digital Zoom



PowerShot A540

AUTO **SCN** **P Tv Av M**

PowerShot A530

AUTO **SCN** **P M**

You can shoot zoomed images using the combined digital and optical zooms.

- Stills: zoom up to approximately 16 times
- Movies (Standard): zoom up to approximately 16 times (PowerShot A540)
: zoom up to approximately 8.1 times (PowerShot A530)



The digital zoom cannot be used when the LCD monitor is turned off.

1

(Rec.) Menu **[Digital Zoom]** **[On]**.

See Menus and Settings (p. 23).



2

Press the zoom lever toward and shoot.

- The combined digital and optical zoom setting will display in the LCD monitor.
- When you press the zoom lever toward , the zoom stops when the lens reaches the maximum optical telephoto setting (when shooting still images). Press the zoom lever toward again to activate the digital zoom and further zoom the image digitally.
- Press the zoom lever toward to zoom out.



- An image will appear coarser the more it is digitally zoomed.
- Digital zoom can only be used in when shooting movies.
- Digital zoom cannot be used in **SCN** (,) mode, or in , , or **W** modes.

Continuous Shooting



PowerShot A540

AUTO Tv Av M

PowerShot A530

AUTO P M

In this mode, the camera shoots continuously while the shutter button is held down.

If you use the recommended memory card*, you can shoot continuously (smooth continuous shooting) at a set shooting interval until the memory card is full (p. 123, 124).

*Recommended Memory Card:

Super high-speed SDC-512MSH memory card (sold separately) to which low-level formatting (p. 30) is conducted immediately before shooting.

- This reflects standard shooting criteria established by Canon. Actual results may vary according to the subject and shooting conditions.
- Even if continuous shooting suddenly stops, the memory card may not be full.

1 FUNC. Menu * (Drive Mode)

See Menus and Settings (p. 22).

* Default setting.



2 Shoot.

- The camera will continue to record successive images while the shutter button is held down. Recording will cease when the shutter button is released.

To Cancel Continuous Shooting

Follow procedure 1 to display



- The interval between shots lengthens when the built-in memory of the camera fills.
- If the flash is used, the interval between shots lengthens because the flash must charge.
- In SCN (,) mode, is not available.

Postcard Date Imprint Mode



PowerShot A540

AUTO **P Tv Av M**

PowerShot A530

AUTO **P M**

You can shoot images with the optimal settings for postcards by composing them inside the print area (width-to-height ratio of approximately 3:2) shown in the LCD monitor.

1 FUNC. Menu * (Postcard).

See Menus and Settings (p. 22).

* Default setting.



- The recording pixels are set to **M2** (1600 x 1200) and the compression to (Fine).
- When the shutter button is pressed halfway, the area that will not get printed in postcard size greys out.



The digital zoom cannot be used in this mode.



For printing instructions, refer to the *Direct Print User Guide*.

Embedding the Date in the Image Data

You can embed the date in image data when  (Postcard Date Imprint Mode) is selected.

1 (Rec.) Menu ► [Date Stamp] ► [Date]/[Date & Time].

See *Menus and Settings* (p. 23).

- LCD monitor display

: [Off]

: [Date]/[Date & Time]

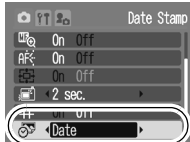

- Ensure that the camera's date/time is set beforehand (p. 26).
- The date stamp cannot be deleted from the image data once it has been set.

Using the Self-Timer



PowerShot A540

AUTO P Tv Av M

PowerShot A530

AUTO P M

You can set a 10 sec. () or 2 sec. () delay, or a custom delay time and the number of shots (Custom Timer), for shooting after the shutter button is pressed.

1 FUNC. Menu * (Drive Mode) / / .

See Menus and Settings (p. 22).

* Default setting.

- : 2 sec. before the shutter releases, the self-timer sound and lamp will speed up.
- : The self-timer sound will play when the shutter button is pressed and the shutter will release 2 sec. later.
- : You can change the delay time (0 – 10, 15, 20, 30 sec.) and number of shots (1 – 10) (p. 38). However, these settings cannot be set for SCN (,), and modes.



2 Shoot.

- When the shutter button is pressed fully, the self-timer lamp will blink. When using red-eye reduction, the self-timer lamp will blink and then stay lit for the last 2 seconds.

To Cancel the Self-Timer

Follow procedure 1 to display .

Changing the Delay Time and Number of Shots (📷)

1



See Menus and Settings (p. 22).



2

Change [Delay]/[Shots] ▶



- The self-timer sound will behave as follows.
 - When a delay time of over 2 seconds is set, the self-timer will start playing 2 seconds before the shutter releases.
 - If multiple shots have been specified for the [Shots] option, the sound will play for the first shot only.



If the [Shots] option is set to 2 or more shots, the following occurs.

- The exposure and white balance are locked at the settings selected for the first shot.
- If the flash is used, the interval between shots lengthens because the flash must charge.
- The interval between shots may lengthen when the built-in memory of the camera fills.
- Shooting will automatically cease if the memory card becomes full.



PowerShot A540



PowerShot A530



The following movie modes are available.

For information on the recording pixels and frame rate in each mode, refer to "Recording Pixels and Frame Rates" (p. 42).

The recording time will differ according to the memory card used (p. 125).

Standard

You can select the recording pixels and frame rate*¹ and record until the memory card is full (when a super high-speed memory card is used, such as the recommended SDC-512MSH).
The digital zoom can be used while shooting in this mode (p. 33).

- Maximum Size: 1 GB/movie*²

Fast Frame Rate (PowerShot A540 only)

Use this mode to record fast moving subjects, such as in sports photography.

- Maximum Clip Length: 1 minute

Compact

Since the recording pixels are few and also the capacity is low, this mode is convenient for sending movies as e-mail attachments or when the memory card capacity is low.

- Maximum Clip Length: 3 minutes

Color Accent, Color Swap

You can have only the specified color remain and change all others into black and white, or change a specified color into a different color (p. 60, 61).





As with the Standard mode, you can select the recording pixels and frame rate*¹ and record until the memory card is full (when a super high-speed memory card is used, such as the recommended SDC-512MSH).

- Maximum Size: 1 GB/movie*²

*¹ The frame rate can be selected only for PowerShot A540.

*² Even if the size of the movie data has not reached 1GB, recording may stop when a shooting time of 1 hour has elapsed.

1 Select a movie mode using the ← or → button.

- In ,  or  mode, you can change the recording pixels and frame rate (p. 41).
- For  and  mode procedures, see "Changing the Color" (p. 60).



2 Shoot.

- Pressing the shutter button halfway automatically sets the exposure, focus and white balance settings.
- Pressing the shutter button fully starts recording video and sound simultaneously.
- During shooting, the recording time and [●Rec] appear on the LCD monitor.
- Pressing the shutter button fully again stops recording. Recording will stop automatically under the following circumstances.
 - When the maximum recording time elapses
 - When the built-in memory or memory card becomes full



- You are recommended to use a memory card that has been formatted in your camera to shoot movies (p. 30). The memory card supplied with the camera may be used without further formatting.
- Be careful of the following while recording.
 - Do not touch the microphone.
 - Do not press any buttons other than the shutter button. The sound that buttons make will be recorded in the movie.
 - The camera will automatically adjust the exposure and white balance to suit the shooting conditions during recording. Please note, however, that the sounds made by the camera automatically adjusting the exposure may also be recorded.
- The focus and optical zoom settings remain fixed for subsequent frames at the values selected for the first frame.



QuickTime 3.0 or later is required to play back movies (Data type: AVI/Compression method: Motion JPEG) on a computer. QuickTime (for Windows) is included on the Canon Digital Camera Solution Disk. On the Macintosh platform, this program is standard with Mac OS X or later.

Changing Recording Pixels and Frame Rates (Movies)

You can change the recording pixels and frame rate* when the movie mode is set to (Standard), (Color Accent) or (Color Swap).

* The frame rate can be changed only for PowerShot A540.

■ PowerShot A540

1 **FUNC. Menu** * (**Recording Pixels**) (**Frame Rate**).

See *Menus and Settings* (p. 22).

* Default setting.

- Use the or button to select a recording pixels/frame rate and press the **FUNC./SET** button.



■ PowerShot A530

1 **FUNC. Menu** * (**Recording Pixels**)

See *Menus and Settings* (p. 22).

* Default setting.



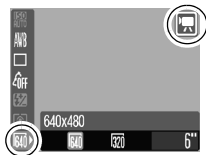









- Use the or button to select the recording pixels and press the **FUNC./SET** button.



Recording Pixels and Frame Rates

Frame rates indicate the number of frames recorded or played back each second. The higher the frame rate, the smoother the appearance of motion.

■PowerShot A540











| | Recording Pixels | Frame Rate (frames/sec.) | | |
|---|--|---|---|---|
| | |  |  |  |
|  Standard |  640 x 480 pixels | – | ○*1 | ○ |
|  Color Accent |  320 x 240 pixels | – | ○ | ○ |
|  Color Swap | | ○ | – | – |
|  Fast Frame Rate*2 |  320 x 240 pixels | ○ | – | – |
|  Compact*2 |  160 x 120 pixels | – | – | ○ |

*1 Default setting.

*2 The recording pixels and frame rate are fixed.

■PowerShot A530

The frame rate is fixed.

| | Recording Pixels | Frame Rate (frames/sec.) | | |
|---|--|---|---|---|
| | |  |  |  |
|  Standard |  640 x 480 pixels | – | – | ○*1 |
|  Color Accent |  320 x 240 pixels | ○ | – | – |
|  Color Swap | | – | ○ | – |
|  Compact |  160 x 120 pixels | – | ○ | – |

*1 Default setting.



- See *Image Data Sizes (Estimated)* (p. 126).
- See *Memory Cards and Estimated Capacities* (p. 123).

Shooting Panoramic Images (Stitch Assist)



PowerShot A540

AUTO SCN P Tv Av M

PowerShot A530

AUTO SCN P M

Stitch Assist can be used to shoot overlapping images that can later be merged (stitched) to create one panoramic image on a computer.

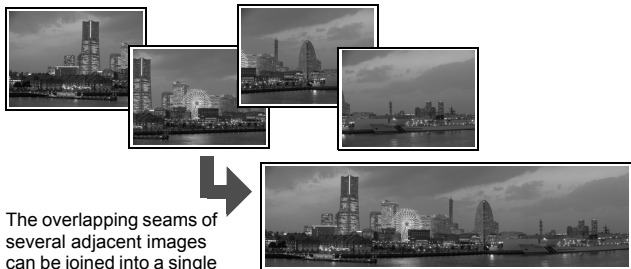

The overlapping seams of several adjacent images can be joined into a single panoramic image.

1 Use the ← or → button to select a shooting direction.



- You can select from the following two shooting directions.
 - → Left to right horizontally
 - ← Right to left horizontally



2 Shoot the first image in the sequence.

- The exposure and white balance are set and locked with the first image.

3 Compose the second image so that it overlaps a portion of the first and shoot.

- You can press the  or  button to return to the previously recorded image to retake the shot.
- Minor discrepancies in the overlapping portions can be corrected when the images are stitched together.

4 Repeat the procedure for additional images.

- A sequence may contain up to 26 images.
- Press the **FUNC./SET** button after the last shot.



- You cannot display the images on a TV when shooting in Stitch Assist mode.
- The settings for the first image are applied to the second image onward.



- Use PhotoStitch, a supplied software program, to merge the images on a computer.
- When the  button is pressed, you can switch between the items which you can set.
 - Exposure compensation/Shooting direction selection

P Program AE



PowerShot A540



PowerShot A530



The camera automatically sets the shutter speed and aperture value to match the brightness of the subject.

- When a correct exposure cannot be obtained, the shutter speed and aperture values are shown in red on the LCD monitor when the shutter button is pressed halfway. Use the following shooting methods to obtain the correct exposure and make them show in white (PowerShot A540 only).
 - Using the flash
 - Changing the ISO speed
 - Changing the metering method

Tv Setting the Shutter Speed



PowerShot A540

AUTO SCN P Tv Av M

When you set the shutter speed, the camera automatically selects an aperture value to match the brightness of the subject. Faster shutter speeds allow you to catch an instantaneous image of a moving subject, while slower speeds create a flowing effect and allow you to shoot without a flash in dark areas.



- If the aperture value is shown in red, the image is underexposed (insufficient light) or overexposed (too much light). Use the \leftarrow or \rightarrow button to adjust the shutter speed until the aperture value shows in white.
- The nature of CCD image sensors is such that noise in the recorded image increases at slow shutter speeds. This camera, however, applies special processing to images shot at shutter speeds slower than 1.3 seconds to eliminate the noise, thereby producing high-quality images. (However, a certain amount of processing time may be required before the next image can be shot.)



- The fastest shutter speed for flash synchronization is 1/500 second. The camera automatically resets the shutter speed to 1/500 second if a faster speed is selected.

Shutter Speed Display

- The following shutter speeds can be set. 1/160 indicates 1/160 second. Also, 0"3 indicates 0.3 second and 2" indicates 2 seconds.

15" 13" 10" 8" 6" 5" 4" 3"2 2"5 2" 1"6 1"3 1" 0"8 0"6 0"5 0"4 0"3
1/4 1/5 1/6 1/8 1/10 1/13 1/15 1/20 1/25 1/30 1/40 1/50 1/60
1/80 1/100 1/125 1/160 1/200 1/250 1/320 1/400 1/500 1/640
1/800 1/1000 1/1250 1/1600 1/2000

Av Setting the Aperture



PowerShot A540

AUTO



SCN



Tv

Av

M

The aperture adjusts the amount of light entering through the lens. When you set the aperture value, the camera automatically selects a shutter speed to match the brightness.

Selecting a lower aperture value (opening the aperture) allows you to blur the background and create a beautiful portrait. A higher aperture value (closing it) brings the entire range from foreground to background into focus. The larger the aperture value, the greater the range of the image brought into clear focus.



- If the shutter speed is shown in red, the image is underexposed (insufficient light) or overexposed (too much light). Adjust the aperture value using the ◀ or ▶ button until the shutter speed display turns to white.
- Some aperture values may not be available with certain zoom positions (p. 47).



In this mode, the shutter speed range with synchronized flash is 1/60 second to 1/500 second. The aperture value setting may therefore be changed automatically to match the synchronized flash speed even if its value was set previously.

Aperture Value Display

- The larger the aperture value, the smaller the lens aperture.

F2.6 F3.2 F3.5 F4.0 F4.5 F5.0 F5.5 F5.6 F6.3 F7.1 F8.0

M Manually Setting the Shutter Speed and Aperture



PowerShot A540

M

PowerShot A530

M

You can manually set the shutter speed and aperture to shoot images.

- When you press the shutter button halfway, the difference between the standard exposure* and the selected exposure appears on the LCD monitor. If the difference is more than ± 2 stops, “-2” or “+2” appears in red.

* Standard exposure levels are calculated by measuring light according to the currently selected metering mode.



- If you wish to change the exposure, select shutter speed or aperture using the button, then adjust the value using the or button.

- If the zoom is adjusted after these values are set, the aperture value may change in accordance with the zoom position.

- The LCD monitor's brightness matches the selected shutter speed and aperture value.

When you select a fast shutter speed or shoot a subject in a dark place, the image will always be bright if the flash is set to (Flash on, with red-eye reduction) or (Flash on).

- The same shutter speeds that can be set for the PowerShot A540, can also be set for the PowerShot A530. See page 45 for details.
- The aperture values that can be set for the PowerShot A530 are shown below. Some aperture values may not be available depending on the zoom position. For the PowerShot A540, see page 46.

F2.6 F3.2 F3.5 F4.0 F4.5 F5.0 F5.5 F5.6 F6.3 F7.1 F8.0 F9.0
F10 F11

- The aperture value and shutter speed change according to the zoom state (p. 48).

PowerShot A540

| | Aperture Value | Shutter Speed (seconds) |
|-------------------------------|-----------------------|------------------------------------|
| Maximum Wide Angle | F2.6 – 3.5 | 15 – 1/1250 |
| | F4.0 – 8.0 | 15 – 1/2000 |
| Maximum Telephoto | F5.5 – 7.1 | 15 – 1/1250 |
| | F8.0 | 15 – 1/2000 |

PowerShot A530

| | Aperture Value | Shutter Speed (seconds) |
|-------------------------------|-----------------------|------------------------------------|
| Maximum Wide Angle | F2.6 | 15 – 1/1250 |
| | F5.6 | 15 – 1/2000 |
| Maximum Telephoto | F5.5 | 15 – 1/1250 |
| | F11 | 15 – 1/2000 |

Selecting an AF Frame



PowerShot A540

AUTO SCN P Tv Av M

PowerShot A530

AUTO SCN P M

The AF frame indicates the area of the composition on which the camera focuses. You can set the AF frame in the following ways.

| | | |
|------------|------------|---|
| (No frame) | On | The camera automatically selects between 9 AF frames to focus on according to the shooting conditions. |
| | Off | The camera focuses using the center AF frame. This is convenient for focusing accurately on your chosen subject to obtain the composition you desire. |

1

(Rec.) Menu ► [AiAF] ► [On] / [Off].

See Menus and Settings (p. 23).

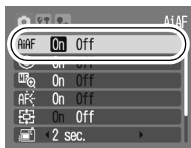

- The focus is locked to the center AF frame when the digital zoom is used.
- The AF frame appears as follows (when the LCD monitor is on) when the shutter button is pressed halfway.
 - Green : Shooting preparations complete
 - Yellow : Focusing difficulty (is set to [Off])

Shooting Hard-to-Focus Subjects (Focus Lock, AF Lock, Manual Focus)



PowerShot A540

AUTO

PowerShot A530

AUTO

It may be difficult to focus on the following types of subjects.

- Subjects with extremely low contrast to the surroundings
- Scenes with a mixture of near and far subjects
- Subjects with extremely bright objects at the center of the composition
- Subjects that are moving quickly
- Subjects through glass: Try to shoot as close to the glass as possible to reduce the chances of light reflecting back off the glass.

Shooting with the Focus Lock

The focus lock can be used in any shooting mode.

- 1 Aim the camera so that an object at the same focal distance as the main subject is centered in the viewfinder or in the AF frame displayed on the LCD monitor.**
- 2 Press the shutter button halfway.**
- 3 Re-aim the camera to compose the shot as desired and press the shutter button fully.**

Shooting with the AF Lock

- 1 Turn on the LCD monitor.**
- 2 Aim the camera so that an object at the same focal distance as the main subject is centered in the AF frame.**

3 Press and hold the shutter button halfway and press the MF button.



- The **MF** icon and the MF indicator will appear on the LCD monitor.

4 Re-aim the camera to compose the shot as desired and shoot.

To Release the AF Lock

Press the **MF** button.





- The AF lock cannot be used in the **AUTO** and  modes, and when **SCN** is set to .
- When shooting with the focus lock or AF lock using the LCD monitor, setting **AtAF** to [Off] (p. 24) makes shooting easier since the camera focuses using the center AF frame only.
- The AF lock is convenient because you can let go of the shutter button to compose the image. Moreover, the AF lock is still effective after the picture is taken, allowing you to capture a second image with the same focus.

Shooting in Manual Focus Mode

The focus can be manually set.

1 Turn on the LCD monitor.

2 Press the MF button several times to display **MF**.





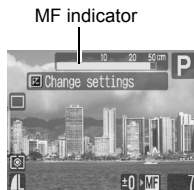

- The MF indicator is displayed.
- When the  (Rec.) menu's  [MF-Point Zoom] is set to [On], the portion of the image in the AF frame will appear magnified*.

* The image will not appear magnified in  mode, when the digital zoom is activated or when a TV is used as the display.

* Can also be set so that the image displayed is not magnified (p. 24).



- Depending on the shooting mode, pressing the  button will switch between the setting items as follows:

| | |
|--|---|
|  P ,  ,  ,  | Exposure compensation/ MF |
| SCN | SCN mode/Exposure compensation/ MF |
|  |  mode/ MF |
| Tv * | Shutter speed/Exposure compensation/ MF |
| Av * | Aperture value/Exposure compensation/ MF |
| M | Shutter speed/Aperture value/ MF |

* PowerShot A540 only



3 Press the or button and adjust the focus.

- The MF indicator shows approximate figures. Use them as a shooting guideline only.

To Cancel the Manual Focus

Press the **MF** button.



The manual focus cannot be used in the **AUTO** and  modes, and when **SCN** is set to .

Switching between Metering Modes

PowerShot A540

     **P** Tv Av M



PowerShot A530

     **P** M

1 **FUNC. Menu** * **(Evaluative)**



See *Menus and Settings* (p. 22).

* Default setting.

- Use the  or  button to select the metering mode and press the **FUNC./SET** button.



Metering Methods

| | | |
|--|--------------------------------|--|
|  | Evaluative | Appropriate for standard shooting conditions, including backlit scenes. The camera divides images into several zones for metering. It evaluates complex lighting conditions, such as the position of the subject, the brightness, the direct light, and the backlighting, and adjusts the settings to the correct exposure for the main subject. |
|  | Center Weighted Average | Averages the light metered from the entire frame, but gives greater weight to the subject matter at the center. |
|  | Spot | Meters the area within the spot AE point at the center of the LCD monitor. Use this setting when you want to set the exposure on the subject in the center of the monitor. |

Adjusting the Exposure Compensation

PowerShot A540

AUTO    SCN   P Tv Av M





PowerShot A530

AUTO    SCN   P M

Adjust the exposure compensation setting to avoid making the subject too dark when it is backlit or shot against a bright background or to avoid making lights appear too bright in night shots.

1 Turn on the LCD monitor.

2 Press the button several times until the exposure compensation bar is displayed.

- Use the  or  buttons to adjust the exposure compensation and press the  button.
- Depending on the shooting mode, pressing the  button will switch between the setting items as follows:





| | |
|-----|--------------------------------------|
| SCN | SCN mode/Exposure compensation |
| Tv* | Shutter speed/Exposure compensation |
| Av* | Aperture value/Exposure compensation |

* PowerShot A540 only

To Cancel the Exposure Compensation

Restore the compensation value to [0].



Exposure compensation is not available in the SCN (, ) modes.



Adjusting the Tone (White Balance)

PowerShot A540

     SCN    

PowerShot A530



     SCN    

Normally, the  (Auto) white balance setting selects an optimal white balance. When the  (Auto) setting cannot produce natural looking colors, change the white balance using a setting appropriate for the light source.

1 FUNC. Menu * (Auto).





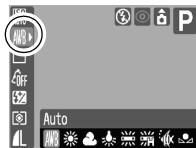

See Menus and Settings (p. 22).

* Default setting.

- Use the  or  button to select a white balance setting and press the FUNC./SET button.



White Balance Settings

| | | |
|---|----------------------|---|
|  | Auto | Settings are automatically set by the camera. |
|  | Day Light | For recording outdoors on a bright day. |
|  | Cloudy | For recording under overcast, shady or twilight skies. |
|  | Tungsten | For recording under tungsten and bulb-type 3-wavelength fluorescent lighting. |
|  | Fluorescent | For recording under warm-white, cool-white or warm-white (3-wavelength) fluorescent lighting. |
|  | Fluorescent H | For recording under daylight fluorescent, or daylight fluorescent-type 3-wavelength fluorescent lighting. |
|  | Underwater* | Appropriate for shooting images with the Waterproof Case WP-DC2 (sold separately). This mode yields image data in the optimal white balance to record images with natural hues by reducing the bluish tone. |

| | | |
|--|---------------|--|
| | Custom | For recording with the optimal white balance data memorized in the camera from a white-colored object, such as white paper or cloth. |
|--|---------------|--|

* PowerShot A540 only



The white balance setting cannot be adjusted when or is selected for My Colors, or when or is selected for Movie Shooting.

Using the Custom White Balance

You can set a custom white balance to obtain the optimal setting for the shooting conditions by having the camera evaluate an object, such as a piece of white paper or cloth, or a photo-quality gray card that you wish to establish as the standard white color.

In particular, take a custom white balance reading for the following situations that are difficult for the (Auto) setting to detect correctly.

- Shooting close-ups (Macro)
- Shooting subjects of monotone color (such as sky, sea or forest)
- Shooting with a peculiar source of light (such as a mercury-vapor lamp)

1 FUNC. Menu ► * (Auto) ► (Custom).

See Menus and Settings (p. 22).

* Default setting.



Aim the camera at a piece of white paper or cloth and press .

- If you are viewing it with the LCD monitor, ensure that the center frame is completely filled with the white image. If you are using the optical viewfinder, ensure that the entire field is filled.



- You are recommended to set the shooting mode to **P** and the exposure compensation setting to $[\pm 0]$ before setting a custom white balance.



The correct white balance may not be obtained when the exposure setting is incorrect (image appears completely black or white).

- Shoot with the same settings as when reading the white balance data. If the settings differ, the optimal white balance may not be set.

In particular, the following should not be changed.

- ISO Speed

- Flash

Setting the flash to on or off is recommended. If the flash fires when reading the white balance data with the flash set to  (Auto) or  (Auto with red-eye reduction), make sure that you also use the flash when you shoot.

- Since the white balance data cannot be read in Stitch Assist mode, preset the white balance in another shooting mode beforehand.
- The camera will retain the custom white balance setting that you record even if you reset the camera to the default settings (p. 29).

Shooting in a My Colors Mode



PowerShot A540

AUTO SCN P Tv Av M

PowerShot A530

AUTO SCN P M

You can change the impression of an image when it is shot.

1 FUNC. Menu * (My Colors Off).

See *Menus and Settings* (p. 22).

* Default setting.

- Use the or button to select a My Colors mode.
- Use the MENU button to switch between and .

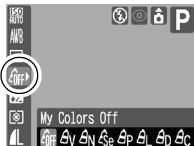

2 Shoot.



- Mode
See *Setting the Camera to a Custom Color Mode* (p. 59).
- Modes other than
Press the **FUNC./SET** button. The display will return to the shooting screen and you can shoot.



In or mode, you cannot make My Color settings.

My Colors Settings

| | | |
|--|----------------------|---|
| | My Colors Off | Records normally with this setting. |
| | Vivid | Emphasizes the contrast and color saturation to record bold colors. |
| | Neutral | Tones down the contrast and color saturation to record neutral hues. |
| | Sepia | Records in sepia tones. |
| | B/W | Records in black and white. |
| | Positive Film | It can produce intense natural-appearing colors like those obtained with positive film. |

| | | |
|---|---------------------------|---|
|  | Lighter Skin Tone* | Use this option to make skin tones lighter. |
|  | Darker Skin Tone* | Use this option to make skin tones darker. |
|  | Custom Color | Use this option to adjust the balance between contrast, sharpness, saturation, reds, greens, blues and skin tones*. It can be used to make subtle adjustments, such as making blue colors more vivid or face colors brighter. |

* The skin colors of non-human subjects may also be altered.

* You may not obtain the expected results depending on the skin color.

Setting the Camera to a Custom Color Mode

1 (Custom Color)

See Menus and Settings (p. 22).



2 Use the **↑** or **↓** button to select [Contrast], [Sharpness], [Saturation], [Red], [Green], [Blue] or [Skin Tone] and the **←** or **→** button to adjust it.

- The altered color will display.



Select an item Adjusting

3

- This completes the setting.

If you press the **MENU** button at this point, you will return to the screen where you can select a My Colors mode.

Changing the Color



Shooting mode SCN () ()

Allows you to easily transform the colors in an image when shooting. This feature can be used for both still shots and movies, and offers you the enjoyment of staging image and movie effects. However, depending on the shooting conditions, there are occasions when the image may appear rough, or you may not obtain the desired color. Therefore, before you shoot important subjects, we recommend that you shoot trial images and check the results. Moreover, when shooting still images, the camera will record both the My Colors image as well as the original unaltered image when [Save Original] (p. 64) is set to [On].

| | | |
|--|--------------|---|
| | Color Accent | Use this option to have only the color specified in the LCD monitor remain and to transform all others to black and white. |
| | Color Swap | Use this option to transform a color specified in the LCD monitor into another. Only one different color can be selected. You cannot choose from among multiple colors. |



- Depending on the scene shot, ISO speed may rise and image noise may increase.

Shooting in the Color Accent Mode

1 Still image: SCN ► ◀ or ▶ button ► 

Movie:  ► ◀ or ▶ button ► 

See *Selecting a Shooting Mode in Basic Guide* (p. 5)



2 
DISP.

- The camera will switch to color input mode and the display will alternate between the original image and the color accent image (using the previously set color).

3 Aim the camera so that the color you wish to retain appears at the center of the LCD monitor and press the ◀ button.

- Only one color can be specified.
- You can use the ▲ or ▼ button to specify the range of colors that are retained.
 - 5: Only takes the color that you want to retain.
 - +5: Also takes colors close to the one that you want to retain.

4 Press  to complete the setting, then shoot.



- The default color accent is green.
- You may not obtain the expected results if you use the flash.
- The specified color accent is retained even if the camera's power is turned off.

Shooting in the Color Swap Mode

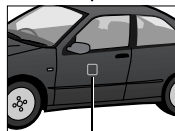

Original Color
(Before Swapping)

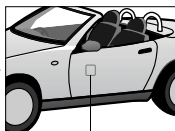

Desired Color
(After Swapping)

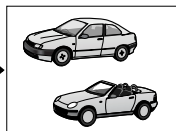

1 Still image: SCN ▶ ◀ or ▶ button ▶

Movie: ▶ ◀ or ▶ button ▶

See *Selecting a Shooting Mode in Basic Guide* (p. 5)



Still image



Movie

2

- The camera will switch to color input mode and the display will alternate between the original image and the color swap image (using the previously set color).



Still image

3 Aim the camera so that the original color appears at the center of the LCD monitor and press the ← button.

- Only one color can be specified.
- You can use the ↑ or ↓ button to specify the range of colors that are swapped.
 - 5: Only takes the color that you want to swap.
 - +5: Also takes colors close to the one that you want to swap.

4 Aim the camera so that the desired color appears at the center of the LCD monitor and press the → button.

- Only one color can be specified.

5 Press  to complete the setting, then shoot.



- The default setting for color swap mode will change green into white.
- You may not obtain the expected results if you use the flash.
- The colors specified in the color swap mode are retained even if the camera's power is turned off.

Changing the Save Method for the Original Image

When you are shooting still images in the Color Accent or Color Swap mode, you can specify whether or not both the altered image and the original image are recorded.

1 (Rec.) Menu ► [Save Original] ► [On]/[Off].

See Menus and Settings (p. 23).

- If [On] is selected, the two images will be numbered consecutively with the altered image following the original.



When [Save Original] is Set to [On]

- Only the color accent or color swap-altered image is shown in the LCD monitor during shooting.
- The image that appears in the LCD monitor immediately after recording is the altered image shot with the color accent or color swap setting. If you erase the image at this point, the original image is erased along with the altered image. Exercise adequate caution before deleting an image.
- Since two images are recorded with each shot, the number of shots remaining is approximately half the number displayed when this function is set to [Off].

Adjusting the ISO Speed



PowerShot A540

AUTO P Tv Av M

PowerShot A530

AUTO P M

Raise the ISO speed to use a fast shutter speed when you wish to reduce the effects of camera shake or avoid blurry subjects, or to turn the flash off when shooting in a dark area.

1 FUNC. Menu * (Auto).

See *Menus and Settings* (p. 22).

* Default setting.

- Use the or button to select an ISO speed and press the **FUNC./SET** button.
- Selecting (Auto) sets the optimal ISO speed according to the light level when shooting. Since the ISO speed setting will automatically be raised in dark places, the camera will select a faster shutter speed and reduce the chances of camera shake.
- In **M** mode, is not available.

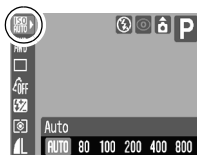

Switching between Flash Adjustment Settings



PowerShot A540

AUTO P Tv Av M

Although the built-in flash will fire with automatic flash adjustments (except in the **M** mode), it is also possible to set it so that it fires without any adjustments.

1 (Rec.) Menu [Flash Adjust] [Auto]/[Manual].

See *Menus and Settings* (p. 23).

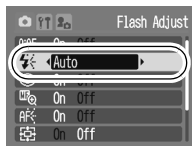

Compensating the Flash Adjustment / Flash Output



PowerShot A540

AUTO Tv Av M

PowerShot A530

AUTO M

+/- (Flash) (Flash Exposure Compensation)

- When the shooting mode is set to , , , , **P** or when [Flash Adjust] is set to [Auto] (p. 65) in **Tv** or **Av** mode, settings can be adjusted in 1/3-stop increments in the range of -2 to +2 stops.
- You can combine the flash exposure compensation with the camera's exposure compensation function to achieve creative effects which compensate for background exposure.

Flash Output

- When Shooting mode is set to **M** or when [Flash Adjust] is set to [Manual] in **Tv** or **Av** mode (p. 65), the flash output can be controlled in three steps, starting from FULL, when shooting.

1 Turn on the LCD monitor.

2 FUNC. Menu (+/- (Flash))/ (Flash Output).

See Menus and Settings (p. 22).

- Adjust the compensation/output using the or button and press the **FUNC./SET** button.



Example:
Flash Exposure
Compensation

Setting the Auto Rotate Function

PowerShot A540

AUTO    **SCN**   **P Tv Av M**



PowerShot A530

AUTO    **SCN**   **P M**

Your camera is equipped with an Intelligent Orientation sensor that detects the orientation of an image shot with the camera held vertically and automatically rotates it to the correct orientation when viewing it in the LCD monitor.

1 (Set up) Menu [Auto Rotate] [On]/[Off].

See *Menus and Settings* (p. 23).

- When the Auto Rotate function is set to [On] and the LCD monitor is set to the detailed display mode during shooting,  (normal),  (right end is down) or  (left end is down) will appear in the display.

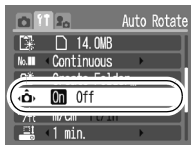







- This function may not operate correctly when the camera is pointed straight up or down. Check that the arrow  is pointing in the right direction and if it is not, then set the Auto Rotate function to [Off].
- Even if the Auto Rotate function is set to [On], the orientation of images downloaded to a computer will depend upon the software used to download the images.



- When the camera is held vertically to shoot, the Intelligent Orientation sensor judges the upper end to be “up” and the lower end to be “down”. It then regulates the optimal white balance, exposure and focus for vertical photography. This function operates regardless of the on/off status of the Auto Rotate function.
- This function can be set separately for the shooting and playback modes.
 - When this function is set to [On] in shooting mode, the orientation will be recorded for the image shot, and the orientation of the image will automatically be altered during playback according to the orientation of the camera during shooting.
 - When this function is set to [On] in playback mode, the top and bottom of the image will be correctly displayed in the LCD monitor according to the orientation of the camera during playback.

Creating an Image Destination (Folder)

PowerShot A540

    SCN   P Tv Av M

PowerShot A530

    SCN   P M

You can create a new folder at any time and the recorded images will be automatically saved to that folder.

| | |
|--------------------------|--|
| Create New Folder | Creates a new folder the next time you shoot images. To create an additional folder, insert the check mark again. |
| Auto Create | You can also specify a date and time if you wish to create a new folder using a shooting time after the specified date and time. |

1 (Set up) Menu ► [Create Folder].

See *Menus and Settings* (p. 23).

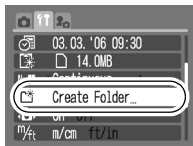

Creating a Folder the Next Time You Shoot.

2 Use the ← or → button to check mark [Create New Folder] ► .

-  displays in the LCD monitor. The symbol will cease to display after the new folder is created.

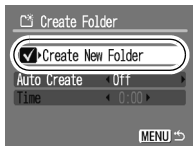

Setting the Day or Time for Automatic Folder Creation.

2 Select a day for the [Auto Create] option and a time in the [Time] option ► .

-  displays when the specified time arrives. The symbol will cease to display after the new folder is created.

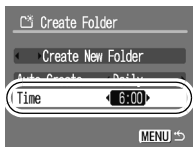

- Up to 2000 images can be saved into one folder. A new folder will automatically be created when you record more than that number even if you are not creating new folders.

Resetting the File Number



PowerShot A540

AUTO SCN P Tv Av M

PowerShot A530

AUTO SCN P M

The images you shoot are automatically assigned file numbers. You can select how the file number is assigned.

1

[i] (Set up) Menu ► **No. [File Numbering]** ► **[Continuous]/Auto Reset**].

See *Menus and Settings* (p. 23).

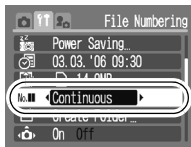

File Number Reset Function

| | |
|-------------------|--|
| Continuous | A number one higher than the last one recorded is assigned to the next image. This is convenient for managing all your images together on a computer because you avoid file name duplication when changing folders or memory cards.* |
| Auto Reset | The image and folder number are reset to the starting value (100-0001).* This is convenient for managing images on a folder-by-folder basis. |

* When a blank memory card is used. If a memory card with recorded data is used, the 7-digit number for the last recorded folder and image is compared with the last one on the card, and the larger of the two is utilized as the basis for new images.

File and Folder Numbers

Recorded images are assigned consecutive file numbers starting with 0001 and ranging up to 9999, while folders are assigned numbers starting with 100 and ranging up to 999. Up to 2,000 images can be saved into a single folder.

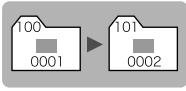
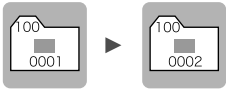
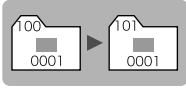
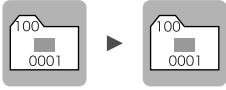
| | New Folder Created | Memory Card Exchanged for Another |
|-------------------|--|--|
| Continuous | Memory Card 1  | Memory Card 1 Memory Card 2  |
| Auto Reset | Memory Card 1  | Memory Card 1 Memory Card 2  |

- Images may be saved to a new folder when there is insufficient free space even if the total number of images in a folder is less than 2,000 because the following types of images are always saved together into the same folder.
 - Images from continuous shooting
 - Self-timer images (custom)
 - Stitch Assist mode images
 - Color Accent and Color Swap still images. (When [Save Original] is set to [On])
- Images cannot be played back when the folder numbers are duplicated or image numbers are duplicated within folders.
- Please refer to the *Software Starter Guide* for information regarding folder structures or image types.

Please also see the *Basic Camera User Guide* (p. 11).

Q Magnifying Images





1 Press the zoom lever toward .

-  will display and a magnified portion of the image will display.
- Images can be magnified up to a factor of approximately 10x.



Approximate Location of the Displayed Area

2 Use the , , or button to move around the image.

- If you press the **FUNC./SET** button while in magnified display, the camera switches to image advance mode and  will display. You can use the  or  button to advance to the next or previous image at the same level of magnification. The image advance mode is cancelled when you press the **FUNC./SET** button again.
- You can change the magnification level with the zoom lever.

To Cancel the Magnified Display

Press the zoom lever toward . (You can also cancel it immediately by pressing the **MENU** button.)







Movie frames and index playback images cannot be magnified.

Viewing Images in Sets of Nine (Index Playback)







1 Press the zoom lever toward .

- Up to nine images can be viewed at once in index playback.
- Use the , ,  or  button to change the image selection.



Switching between Sets of Nine Images

The jump bar will display if you press the zoom lever toward  while in index playback and you can switch the display between sets of nine images.

- Use the  or  button to move to the previous or next set of 9 images.
- Hold the **FUNC./SET** button down and press the  or  button to jump to the first or last set.

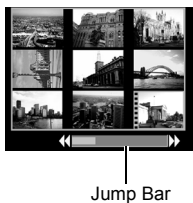





To Return to Single Image Playback

Press the zoom lever toward .

Jumping to Images



When you have many images recorded onto a memory card, it is handy to use the five search keys below to jump over images to find the object of your search.

| | | |
|---|-----------------|---|
|  | Jump 10 Images | Jumps over 10 images at a time. |
|  | Jump 100 Images | Jumps over 100 images at a time. |
|  | Shot Date | Jumps to the first image of each shooting date. |
|  | Movie | Jumps to a movie. |
|  | Folder | Jumps to the first image of each folder. |

1 In single image playback mode, press the button.

- The camera will switch to jump search mode.
- The screen sample will vary slightly according to the search key.



Location of image currently being displayed

Number of images matching search key

2 Use the or button to select a search key and press the or button.

To Return to Single Image Playback

Press the **MENU** button.



Movies cannot be played in the index playback mode.

1 Display a movie and press



- Images with a icon are movies.



Movie Control Panel

Volume Level
(Adjust it with the
↑ or ↓ button)

2 Select (Play) and press .

- The movie will pause if you press the **FUNC./SET** button during playback. It will resume when you press the button again.
- When playback ends, the movie stops at the last frame displayed. Press the **FUNC./SET** button to display the movie control panel.

Operating the Movie Control Panel

| | |
|--|--|
| | Ends playback and returns to single image playback |
| | Prints (An icon will display when a printer is connected. See the <i>Direct Print User Guide</i> for details.) |
| | Play |
| | Slow Motion Playback (You can use the button to slow down or the button to speed up playback.) |
| | Displays the first frame |
| | Previous Frame (Rewinds if the FUNC./SET button is held down.) |
| | Next Frame (Fast Forwards if the FUNC./SET button is held down.) |
| | Displays the last frame |
| | Edit (Switches to movie editing mode.) (p. 76) |



- Use the television's controls to adjust the volume when playing a movie on a TV set (p. 88).
- The sound cannot be played in slow motion playback.

Editing Movies



You can delete portions of recorded movies.



Movies that are protected or less than 1 second long cannot be edited.

1 Select (Edit) in the movie control panel and press .



- The movie editing panel and the movie editing bar will display.

Movie Editing Panel



Movie Editing Bar

2 Use the or button to select (Cut Beginning) or (Cut End) and the or button to specify the cut point (↓).

- To check a temporarily edited movie, select  (Play) and press the **FUNC./SET** button.
- Selecting  (Exit) cancels the edit and restores the movie control panel.

3 Select (Save) and press .

4

Select [New File] or [Overwrite] and press  .

- [New File] saves the edited movie under a new file name. The pre-edit data is left unchanged.

Note, if you press the **FUNC./SET**

button while saving the movie, saving is cancelled.

- [Overwrite] saves the edited movie with its original name. The pre-edit data is lost.
- When there is not enough space left on the memory card, only [Overwrite] can be selected.



It may take approximately 3 minutes to save an edited movie. If the batteries run out partway through, edited movie clips cannot be saved. When editing movies, it is recommended to use new AA-size alkaline batteries or fully charged AA-size NiMH batteries (sold separately) or the AC Adapter Kit ACK800 (sold separately) ([p. 108](#)).

Rotating Images in the Display



Images can be rotated clockwise 90° or 270° in the display.

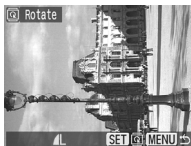

Original



90°



270°

1 (Play) Menu

See Menus and Settings (p. 23).



2 Use the or button to select an image to rotate and press to rotate it.

- Cycle through the 90°/270°/original orientations with each press of the **FUNC./SET** button.
- This also can be set in the index playback mode.



- Movies cannot be rotated.
- When images are downloaded to a computer, the orientation of images rotated by the camera will depend upon the software used to download the images.

Attaching Sound Memos to Images

In playback mode (including single image playback and index playback), you can attach sound memos (up to 1 min.) to an image. The sound data is saved in the WAVE format.

1 (Play) Menu .

See Menus and Settings (p. 23).



2 Use the \leftarrow or \rightarrow button to select an image to which to attach a sound memo and press



- The sound memo control panel will display.

3 Select (Record) and press .

- The elapsed time and the remaining time display.
- Pressing the **FUNC./SET** button pauses the recording. Pressing it again resumes recording.
- Up to 1 min. of recordings can be added to any one image.







Sound Memo Panel

Elapsed Time/
Remaining Time

Volume
(Adjust it with the
 \uparrow or \downarrow button)

Sound Memo Panel

| | |
|---|---|
|  | Exit |
|  | Record |
|  | Pause |
|  | Play |
|  | Erase Select [Erase] in the confirmation screen and press the FUNC./SET button. |



- You cannot attach sound memos to movies.
- Sound memos for protected images cannot be erased.

Automated Playback (Auto Play)

Use this feature to automatically play back all of the images in the memory card. The LCD monitor displays each image for approximately 3 seconds.

1 (Play) Menu .

See Menus and Settings (p. 23).



2 Press .

- During automated playback, the following functions are possible:
 - Pausing/resuming the Auto Play: Press the **FUNC./SET** button
 - Fast forwarding/rewinding: Press the **◀** or **▶** button (hold down the button to switch between images more rapidly)
 - Stopping the Auto Play: Press the **MENU** button

Protecting Images



You can protect important images and movies from accidental erasure.

1 (Play) Menu

See *Menus and Settings* (p. 23).

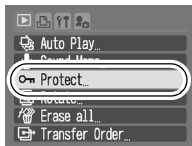

2 Use the or button to select an image to protect and press .

- Pressing the **FUNC./SET** button again cancels the setting.
- You can also protect images in the index playback mode.



Protection Icon

Erasing All Images



- Note that erased images cannot be recovered. Exercise adequate caution before erasing an image.
- Protected images cannot be erased with this function.

1

(Play) Menu

See *Menus and Settings* (p. 23).



2

Select [OK] and press

- To exit instead of erasing, select [Cancel].



Please format the memory card when you want to erase not only image data but also all the data contained on the memory card (p. 30).

Print Settings/Transfer Settings

Setting the DPOF Print Settings

You can select images on a memory card for printing and specify the number of print copies in advance using the camera. The settings used on the camera comply with the Digital Print Order Format (DPOF) standards. This is extremely convenient for printing on a direct print compatible printer, or for sending the images to a photo developing service that supports DPOF.

The  icon may display for a memory card with print settings set by a different DPOF-compliant camera. These settings will be overwritten by those set by your camera.

Single Images



1 (Print) Menu ► [Select Images & Qty.]

- Selecting [Clear All Selections] cancels all print settings.



2 Use the ← or → button to select images for printing.

- Selection methods differ for the Print Type settings (p. 85).

-  (Standard)/ (Both)
Select an image, press the **FUNC./SET** button and use the ↑ or ↓ button to select the number of print copies (up to 99).



Number of Print Copies



-  (Index)
Select an image and press the **FUNC./SET** button to select or deselect it.



Index Print Selection



- You can also select images in the index playback mode.
- If the camera is connected to a printer, the  button will light in blue while images are being selected. At this time, press the  button, confirm that [Print] is selected, and when the **FUNC./SET** button is pressed, printing will begin.

All the Images on a Memory Card

1 (Print) Menu ► [Select All Images].

- One copy of every image will be set to print.
- Selecting [Clear All Selections] cancels all print settings
- When the camera is connected to a printer, after the **FUNC./SET** button is pressed, the  button will light in blue. At this time, press the  button,

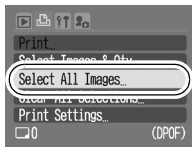

confirm that [Print] is selected, and when the **FUNC./SET** button is pressed, printing will begin.



- The output of some printers or photo developing services may not reflect the specified print settings.
- Print settings cannot be set for movies.



- Images are printed in order according to the file number.
- A maximum of 998 images can be selected.
- When [Print Type] is set to [Both], the number of copies can be set. When it is set to [Index], the number of copies cannot be set (only one copy will be printed).

Setting the Print Style

After setting the print style, select the images for printing. The following settings can be selected.

*Default setting

| | | |
|--|----------------------------------|---|
| | Standard* | Prints one image per page. |
| | Index | Prints the selected images together at a reduced size in an index format. |
| | Both | Prints the images in both the standard and index formats. |
| | Date (On/Off*) | Adds the date to the print. |
| | File No. (On/Off*) | Adds the file number to the print. |
| | Clear DPOF data (On*/Off) | Clears all print settings after the images print. |

1

(Print) Menu ► **[Print Settings]** ►

See Menus and Settings (p. 23).



2

Select [Print Type], [Date], [File No.], [Clear DPOF data] and then specify the settings.



- The Date and File No. settings change according to the Print Type as follows.
 - Index
[Date] and [File No.] cannot be set to [On] at the same time.
 - Standard or Both
[Date] and [File No.] can be set to [On] at the same time, however, the printable information may vary between printers.
- Embedded dates in  (Postcard Date Imprint mode) (p. 35) print out even when [Date] is set to [Off].
- Dates print in the style specified in the [Date/Time] menu (p. 26, *Basic Guide* p. 3).
- Do not set the date in the DPOF print settings when printing images that have had the date embedded with the [Date Stamp] function. This may cause the date to be printed twice.

Setting the DPOF Transfer Settings

You can use the camera to specify settings for images before downloading to a computer. Refer to the *Software Starter Guide* for instructions on how to transfer images to your computer.

The settings used on the camera comply with the Digital Print Order Format (DPOF) standards.

The  icon may display for a memory card with transfer settings set by a different DPOF-compliant camera. These settings will be overwritten by those set by your camera.

1 (Play) Menu .

See Menus and Settings (p. 23).



Single Images

2 Select [Order] and press .

- Selecting [Reset] cancels all transfer order settings.

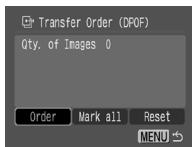

3 Use the **←** or **→** button to select an image to transfer and press .

- Pressing the **FUNC./SET** button again deselects the setting.
- You can also select images in the index playback mode.



All the Images on a Memory Card

2 Select [Mark all] and press .

- Selecting [Reset] cancels all transfer order settings.

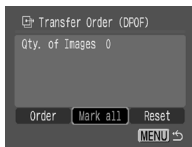

3 Select [OK] and press .



- Images are transferred in order according to the file number.
- A maximum of 998 images can be selected.

Viewing Images on a TV set

You can use a video-compatible television as a monitor to shoot or play back images when it is connected to the camera with the supplied AV Cable.

1 Turn off the Camera and the TV.

2 Connect the AV cable to the camera's A/V OUT terminal.

- Open the terminal cover by slipping a fingernail under the lower end and plug the AV cable in all the way.

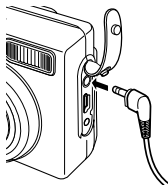

3 Plug the other ends of the AV cable to the VIDEO IN and AUDIO IN jacks on the TV.

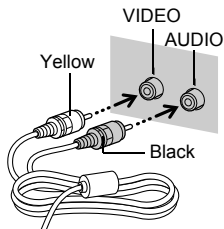

4 Turn on the TV and switch it to Video mode.

5 Turn on the camera.



The video output signal can be switched (NTSC or PAL) to accommodate different regional standards (p. 27). The default setting varies between regions.

- NTSC: Japan, U.S.A., Canada, Taiwan and others
- PAL: Europe, Asia (excluding Taiwan), Oceania and others

If the video system is set incorrectly, the camera output may not display properly.

Troubleshooting

Camera

Camera will not operate.

| | |
|---|--|
| Power is not turned on. | ● Press the power button (<i>Basic Guide</i> p. 4). |
| Memory card slot/battery cover is open. | ● Confirm that the memory card slot/battery cover is securely closed (<i>Basic Guide</i> p. 1). |
| Batteries are loaded in the wrong direction. | ● Reload the batteries in the correct direction (<i>Basic Guide</i> p. 1). |
| Batteries are not the right type. | ● Use only unused AA-size alkaline batteries or Canon AA-size NiMH batteries (<i>Basic Guide</i> p. 1). |
| Insufficient battery voltage (“Change the batteries” message displays). | ● Replace the camera batteries with 2 unused or fully charged batteries (<i>Basic Guide</i> p. 1). ● Use the AC Adapter Kit ACK800 (sold separately) (p. 108). |
| Poor contact between camera and battery terminals. | ● Wipe the battery terminals with a clean dry cloth. ● Reload the batteries several times. |

Sounds come from the camera interior.

| | |
|---|---|
| The camera’s horizontal/vertical orientation was changed. | ● The camera’s orientation mechanism is operating. There is no malfunction. |
|---|---|

When the power is turned on

“Card locked!” message appears.

| | |
|---|---|
| The SD memory card’s write protect tab is set to “Write protect”. | ● When recording to, erasing from or formatting the memory card, slide the tab upward (p. 104). |
|---|---|

The Date/Time menu appears.

The lithium date/time battery charge is depleted.

- Replace the lithium date/time battery (p. 114).

LCD monitor

The display darkens.

The image in the LCD monitor will darken in strong sunlight or bright light.

- This is a normal occurrence in devices containing CCDs and does not constitute a malfunction. This image will not be recorded when shooting still photos, but it will be recorded when shooting movies.

Display flickers.

Display flickers when shot under fluorescent lighting.

- This is not a camera malfunction (flickering recorded in movies, but not in still images).

A bar of light (red, purple) appears on the LCD monitor.

Subject is too bright.

- This is a normal occurrence in devices containing CCDs and does not constitute a malfunction. This bar of light will not be recorded when shooting still photos, but it will be recorded when shooting movies.

appears.

A slow shutter speed has likely been selected because of insufficient lighting.

- Raise the ISO speed (p. 65) or set the flash to any setting other than  (flash off), or secure the camera to something, such as a tripod (p. 17).

appears.

This displays when using a memory card that has print settings or transfer settings set by other DPOF-compliant cameras.

- These settings will be overwritten by those set by your camera (p. 86).

Noise displays./Subject's movements are irregular.

Camera automatically lightened the image displayed on the LCD monitor to make it easier to see when shooting in a dark area (p. 15).

- There is no effect on the recorded image.

Shooting

Camera will not record.

Mode switch is set to  (playback).

- Set the mode switch to  (shooting) (*Basic Guide* p. 4).

Flash is charging.

- When the flash is charged, the indicator will light orange. Shooting is now possible (p. 20).

Memory card is full.

- Insert a new memory card (*Basic Guide* p. 1).
- If required, download the images to a computer and erase them from the memory card to make space.

Memory card is not formatted correctly.

- Format the memory card (p. 30).
- If reformatting does not work, the memory card logic circuits may be damaged. Consult the nearest Canon Customer Support Help Desk.

SD memory card is write protected.

- Slide the write protect tab of the SD memory card upward (p. 104).

Image Seen in Viewfinder vs. Recorded Image

Usually the recorded image contains more of the scene than is seen in the viewfinder.

- Confirm the actual image size with the LCD monitor. Use the LCD monitor when taking close-up shots (p. 15).

Image is blurred or out of focus.

AF-assist Beam is set to [Off].

- In dark places where it is difficult for the camera to focus, the AF-assist Beam will emit to assist focusing. As the AF-assist Beam will not function when turned off, set it [On] to activate it (p. 24). Take care not to obstruct the AF-assist Beam with your hand when used.

The camera moves when the shutter button is pressed.

- Setting the self-timer to  (2 seconds) delays the shutter release for 2 seconds after the shutter button is pressed and allows the camera to stop shaking, thus preventing a blurred image (p. 37).
Even better results can be obtained by placing the camera on a stable surface or by using a tripod to shoot.

Subject is out of focal range.

- Shoot with the subject at the correct shooting distance (p. 118).

The subject is hard to focus on.

- Use the focus lock, AF lock or manual focus to shoot (p. 50).

Subject in recorded image is too dark.

Insufficient light for shooting.

- Set the flash to  (Flash on) (*Basic Guide* p. 8).

The subject is underexposed because the surroundings are too bright.

- Set the exposure compensation to a positive (+) setting (p. 54).
- Use the spot metering function (p. 53).

Subject is too far away for flash to reach.

- Shoot within correct shooting distance of the subject when using the built-in flash (p. 118).
- Raise the ISO speed and then shoot (p. 65).

Subject in recorded image is too bright, or image flashes white.

Subject is too close, making the flash too strong.

- Shoot within correct shooting distance of the subject when using the built-in flash (p. 118).

The subject is overexposed because the surroundings are too dark.

- Set the exposure compensation to a negative (-) setting (p. 54).
- Use the spot metering function (p. 53).

Too much light is shining directly into the camera, or is being reflected off the subject.

- Change the shooting angle.

Flash is set to on.









- Set the flash to  (Flash off) (*Basic Guide* p. 8).

Image contains noise.

ISO speed is too high.

- Higher ISO speeds may increase image noise. For higher image quality, use as low an ISO speed as possible (p. 65).
 - In , , , *, , ,  and  modes in the SCN mode, the ISO speed increases and noise can appear.
- * PowerShot A540 only

White dots appear on the image.

Light from the flash has reflected off dust particles or insects in the air. This is particularly noticeable when shooting using the wide angle or when you increase the aperture value in the aperture-priority AE mode*.

* PowerShot A540 only

- This is a phenomenon that occurs with digital cameras and does not constitute a malfunction.

Eyes appear red.

Light is reflected back from the eyes when the flash is used in dark areas.

- Use the  (red-eye reduction) mode (*Basic Guide* p. 8). For this mode to be effective, the subject must be looking right at the red-eye reduction lamp. Try asking them to look directly at the lamp.
- Even better results can be obtained by increasing the lighting in indoor settings or approaching closer to the subject. The shutter will not activate for approximately 1 second after the red-eye reduction lamp fires in order to improve the effect.

Continuous shooting slows down.

The memory card's performance has dropped.

- To enhance the continuous shooting performance, you are recommended to format the memory card in the camera after you save all its images to your computer (p. 30).

Recording images to memory card takes a long time.

Memory card was formatted in another device.

- Use a memory card formatted in your camera (p. 30).

Lens will not retract.

Memory card slot cover/ battery cover was opened with power on.

- After closing the memory card slot/ battery cover, turn the power on then back off (*Basic Guide* p. 1).

Shooting Movies

The recording time may not display properly or filming may stop unexpectedly.

The following types of memory cards are used.

- Slow recording cards.
- Cards formatted on a different camera or a computer.
- Cards which have had images recorded and erased repeatedly.

- Although the recording time may not display properly during shooting, the movie will be recorded correctly on the memory card. Recording time will display properly if you format the memory card in this camera (excluding slow recording memory cards) (p. 30).

“!” displays on the LCD monitor in red and shooting automatically stopped.

There is insufficient free space in the camera's built-in memory.

- Try the following procedures.
 - Format the card with a low level format before filming (p. 30)
 - Lower the recording pixels or the frame rate* (p. 41)
 - * The frame rate can be changed only for PowerShot A540.
 - Use a high-speed memory card (SDC-512MSH, etc.)

Zoom does not operate.

Zoom lever was pressed while shooting in movie mode.

- Operate the zoom before shooting in movie mode (*Basic Guide* p. 8). Note the digital zoom is available while shooting, but only in Standard movie mode.

Playback

Cannot play back.

You attempted to play back images shot with another camera or images edited with a computer.

- Computer images that cannot be played back will play back if they are added to the camera using the supplied software program ZoomBrowser EX or ImageBrowser.

File name was changed with a computer or file location was changed.

- Set the file name or location on the file format/structure of the camera. (Refer to the *Software Starter Guide* for details).

Movies cannot be edited.

Some movies shot with another camera cannot be edited.

Movies do not play back correctly.

Movies recorded with high recording pixels and frame rates may momentarily stop playing if played on slow reading memory cards.

You may experience frame dropping and audio breakup when playing back a movie on a computer with insufficient system resources.

Movies recorded at the  (Fast Frame Rate)* setting and with the video signal set to the PAL format, may play back with a frame rate lower than the recorded one when output to a TV or video. You can play every frame by using the slow motion playback.

*PowerShot A540 only

- To check the images at the original frame rate, you are recommended to play the movie back on the camera's LCD monitor or on a computer.

Reading images from memory card is slow.

Memory card was formatted in another device.

- Use a memory card formatted in your camera (p. 30).

Battery

Batteries consumed quickly.

Batteries are not the right type.

- Use only unused AA-size alkaline batteries or Canon AA-size NiMH batteries (*Basic Guide* p. 1).

Battery capacity drops due to low ambient temperatures.

- If shooting in a cold location, warm the batteries such as by placing them in your pocket before using them.

Battery terminals are dirty.

- Wipe the terminals well with a dry cloth before use.
- Reload the batteries several times.

If using Canon AA-size NiMH batteries

As the batteries have not been used for over a year, their recharging capacity has decreased.

- Their charging performance should return to normal after fully recharging and fully depleting them over several times.

Battery life has been exceeded.

- Replace both batteries with new ones.

TV monitor output

Image not showing on TV monitor.

Incorrect video system setting.

- Set the video system to the appropriate setting, NTSC or PAL, for your TV (p. 27).

Shooting in Stitch Assist mode.

- The output will not appear on a TV in Stitch Assist mode. Shoot in a different shooting mode (*Basic Guide* p. 5).

Printing with a direct print compatible printer

Cannot print

| | |
|--|--|
| The camera and printer are not properly connected. | ● Securely connect the camera and printer with the specified cable. |
| The printer power is not turned on. | ● Turn on the printer power. |
| The print connection method is not correct. | ● In the [[(Set up) menu, select [Print Method] and select [Auto] (p. 27). |

List of Messages

The following messages may appear on the LCD monitor during shooting or playback. Please refer to the *Direct Print User Guide* for the messages that display during a printer connection.

Busy...

Image is being recorded to, or read from, memory card. The playback mode is starting up.

No memory card

You turned on the camera without a memory card installed.

Card locked!

The SD memory card is write-protected.

Cannot record!

You attempted to shoot an image without a memory card installed, or attempted to attach a sound memo to a movie.

Memory card error

Memory card has experienced an anomaly.

Memory card full

Memory card is full of images and no more can be recorded or saved. Or no more image settings or sound memos can be recorded.

Naming error!

The image could not be created because there is an image with the same name as the folder that the camera is attempting to create, or the highest possible file number has already been reached. In the Set up menu, set [File Numbering] to [Auto Reset]. Save all the images you wish to retain onto a computer, then reformat the memory card. Please note that formatting will erase all the existing images and other data.

Change the batteries

Battery charge is insufficient to operate the camera. Replace both batteries immediately with unused AA-size alkaline batteries or fully charged Canon AA-size NiMH batteries.

No image

No images recorded on memory card.

Image too large

You attempted to play back an image larger than 4992 x 3328 pixels or with a large data size.

Incompatible JPEG format

You attempted to play back an incompatible JPEG image.

Corrupted Data

You attempted to play back an image with corrupted data.

RAW

You attempted to play back a RAW image.

Unidentified Image

You attempted to play back an image that was recorded in a special data type (proprietary data type used by the camera of another manufacturer, etc.) or a movie clip recorded by another camera.

Cannot magnify!

You attempted to magnify an image recorded in a different camera or data type, an image edited with a computer, or a movie.

Cannot rotate

You attempted to rotate an image recorded in a different camera or data type, an image edited with a computer, or a movie.

Incompatible WAVE format.

A sound memo cannot be added to this image since the data type of the existing sound memo is incorrect.

Cannot transfer!

When transferring images to your computer using the Direct Transfer menu, you attempted to select an image with corrupted data or an image taken with another camera. You may have also attempted to select a movie when [Wallpaper] was selected in the Direct Transfer menu.

Protected!

You attempted to erase or edit a protected image, movie or sound memo.

Too many marks

Too many images have been marked with print settings or transfer settings. Cannot process any more.

Cannot complete!

Could not save the print or transfer settings.

Unselectable image

You attempted to set the print settings for a non-JPEG image.

Communication error

The computer was unable to download the image due to the large amount of images (approx. 1000) stored on the memory card.

Lens error, restart camera

An error was detected while the lens was in motion, and the power has been automatically turned off. This error can occur if you hold the lens while it is in motion or you operate it in a location with excessive dust or sand in the air. Try turning the power back on, and resume shooting or playback. If this message continues to display, contact your Canon Customer Support Help Desk as there may be a problem with the lens.

Exx

(xx: number) Camera detected an error. Turn the power off and then back on, then shoot or play back. A problem exists if the error code reappears. Note the number and contact your Canon Customer Support Help Desk. If an error code displays directly after taking a picture, the shot may not have been recorded. Check image in playback mode.

Battery Handling

Battery Charge

The following icon and message will display.



Battery charge is low. If using the camera for an extended period, replace the batteries as soon as possible.

Change the batteries

Batteries are fully depleted and the camera can no longer operate. Replace the batteries immediately.

Battery Handling Precautions

- **This camera uses AA-size alkaline batteries or Canon AA-size NiMH batteries (sold separately).**
While it is possible to use AA-size nickel-cadmium batteries, performance is unreliable and their use is not recommended.
- **Since the performance of alkaline batteries may differ according to brand, the operating time of the batteries you purchase may not be as long as the batteries that came with the camera.**
- **When using the camera under low temperature conditions or over long periods, you are recommend to use of Canon AA-size NiMH batteries (sold separately).**
Camera operating time may shorten at low temperatures when alkaline batteries are used. Also due to their specifications, alkaline batteries may expire faster than NiMH batteries.
- **Never mix unused and partially used batteries.**
The partially used batteries may leak.
- **Do not install the batteries with their terminals (⊕ and ⊖) reversed.**
- **Do not mix batteries of different types or from different manufacturers.**

- **Before installing the batteries, wipe the battery terminals well with a dry cloth.**

If the battery terminals are soiled with oil from one's skin or other dirt, the number of recordable images may be considerably diminished, or reduced usage time.

- **At low temperatures, battery performance may be reduced and the low battery icon () may appear earlier than usual.**

Under these conditions, restore the battery performance by warming it in a pocket immediately before use.

- **Do not put the batteries into a pocket together with metallic items such as a key ring.**

The batteries may be short circuited.

- **When not using the camera for long periods, remove the batteries from the camera and store them separately.**

If the batteries are left inside the camera, the camera may become damaged from battery leakage.



WARNING

Never use damaged batteries or batteries whose outer seal is completely or partially missing or peeled off, as there is risk that such batteries may leak, overheat, or burst. Always check the seals on store-bought batteries before loading them, as some batteries may come with defective seals. Do not use batteries with defective seals.

Never use batteries that look like this.



Batteries with all or part of the seal (electrical insulation sheath) peeled off.



The positive electrode (plus terminal) is flat.



The negative terminal is correctly formed (protruding from the metal base), but the seal does not extend up over the edge of the metal base.

Handling the Memory Card

SD Memory Card Write Protect Tab

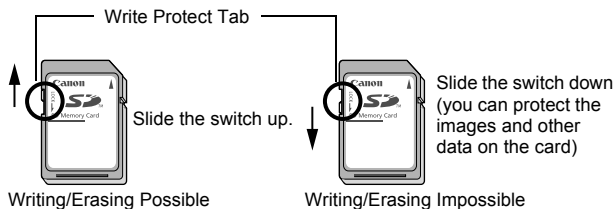

Cautions When Handling

- **Memory cards are high-precision electronic devices. Do not bend them, apply force to them, or subject them to shocks or vibration.**
- **Do not attempt to disassemble or alter the memory card.**
- **Do not allow dirt, water or foreign objects to contact the terminals on the back of the card. Do not touch the terminals with your hands or metal objects.**
- **Do not peel away the original label on the memory card or cover it with another label or sticker.**
- **When writing on the memory card, do not use a pencil or ball-point pen. Only use a soft point pen (e.g. felt-tip pen).**
- **Do not use or store memory cards in the following locations.**
 - Locations subject to dust or sand
 - Locations subject to high humidity and high temperatures
- **Since some or all of the data recorded on the memory card may be corrupted or erased by electrical noise, static electricity or card malfunction, making a backup copy of important data is recommended.**

Formatting

- **Please note that formatting (initializing) an memory card erases all data, including protected images.**
- **You are recommended to use memory cards that have been formatted in your camera.**
 - The card supplied with the camera may be used without further formatting.
 - When the camera is malfunctioning, a corrupted memory card might be the cause. Reformatting the memory card may solve the problem.
 - When a non-Canon brand memory card is malfunctioning, reformatting it may solve the problem.
 - Memory cards formatted in other cameras, computers, or peripheral devices may not operate correctly in this camera. When that happens, reformat the memory card with this camera.
- **If formatting in the camera does not work properly, turn the camera off and re-insert the memory card. Then turn the camera back on and format again.**

Using the Power Kits (Sold Separately)

Using Rechargeable Batteries (Battery and Charger Kit CBK4-300)

This kit includes a battery charger and four rechargeable AA-size NiMH (nickel metal hydride) batteries. Charge batteries as shown below. Recharging is also possible using two batteries.

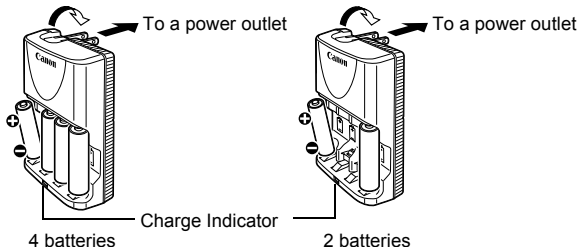

- After inserting the batteries, plug the charger (CB-5AH) into an outlet, or attach the power cord to the charger (CB-5AHE, not shown) and plug the other end into an outlet.
- Do not insert and charge additional batteries once charging has begun.
- The charge indicator blinks while charging, then remains lit when charging is finished.



- The CB-5AH/CB-5AHE battery charger can only be used to charge Canon AA-size NiMH Battery NB-3AH and NB-2AH. Please do not attempt to charge any other type of battery.
- Do not mix batteries with different purchase dates or different charge states. When recharging batteries, always recharge all 4 of them at the same time.
- Do not attempt to recharge fully charged batteries, as doing so may reduce or impair battery performance. Also, do not charge batteries for more than 24 consecutive hours.
- Do not recharge batteries in enclosed areas that tend to retain heat.
- Do not recharge the batteries until the LCD monitor displays the "Change the batteries" message. Repeatedly recharging batteries before they become fully depleted may cause batteries to lose capacity.

- Wipe the battery terminals well with a dry cloth in the following situations, as the terminals may be soiled with oil from one's skin or other dirt:
 - If the battery usage time has considerably diminished
 - If the number of recordable images has considerably diminished
 - When charging the batteries (insert and remove the batteries two or three times before charging)
 - When charging completes in a space of a few minutes (the battery charger indicator remains lit)
- You may not be able to fully charge the batteries due to their specifications right after purchase or after long periods of nonuse. If this happens, after fully charging them, use the batteries until their charge is fully depleted. After doing this several times, battery performance will be restored.
- If you store batteries for a long period of time (about 1 year), it is recommended that you fully deplete the batteries in the camera and to then store them at room temperature (0 to 30°C/32 to 90°F) in low humidity. Storing them in a fully charged condition can shorten their lifespan or degrade their performance.

Again, if you do not use batteries for more than 1 year, fully charge them once a year and fully deplete in the camera before storing them.
- If the battery usage time has become considerably low despite wiping the terminals and charging them until the battery charger indicator remains lit, this may indicate that the batteries have reached the end of their lifespan. Replace them with new batteries. If you are purchasing new batteries, look for Canon AA-size NiMH batteries.
- Leaving batteries in the camera or charger may result in damage from battery leakage. When not in use, remove the batteries from the camera or charger and store them in a cool, dry location.



- It takes approximately 4 hours 40 minutes for the charger to fully recharge the batteries after they have been fully discharged. When two batteries are placed on each side of the charger, recharging will take approximately two hours (as determined by testing at Canon facilities). Charge batteries in an environment where the temperature is in the range of 0 to 35°C (32 to 95°F).
- The charging time varies according to the ambient temperature and to the battery charge state.
- The battery charger may emit noise while charging. This is not a malfunction.
- Battery/Charger Kit CBK4-200 can also be used.

Using the AC Adapter Kit ACK800

It is best to power the camera with AC Adapter Kit ACK800 (sold separately) when you are using it for long periods of time or connecting it to a computer.



Turn the camera power off before connecting or disconnecting the AC adapter.

1

Connect the power cord to the compact power adapter first and then plug the other end into the power outlet.

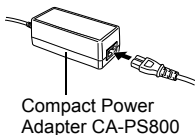

2

Open the terminal cover and attach the cord to the DC IN terminal.

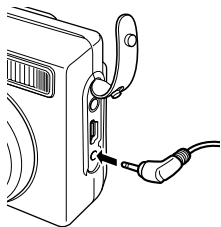

Using the Lenses (Sold Separately) (PowerShot A540 only)

The camera supports use of the separately sold Wide Converter WC-DC52, Tele-converter TC-DC52A and Close-up lens 250D (52mm). In order to attach these lenses, you also need to use the separately sold Conversion Lens Adapter LA-DC52F.



- When attaching the wide converter, tele-converter or close-up lens be sure to screw it on securely. If they come loose, they may fall from the lens adapter, posing risk of injury from shattered glass.
- Never look into the sun or into strong light through the viewfinder, wide converter, tele-converter or close-up lens as this can result in blindness or impairment of vision.



- If you use the flash when shooting with these attachments, the outer area of the recorded image (especially lower right corner) will come out relatively dark.
- When using the tele-converter, please set the focal length to the telephoto end. At other zoom settings, the image will appear as if its corners have been cut off.
- When using the wide converter, please set the camera to the wide angle end.
- If you use the viewfinder for shooting, a portion of the view will be blocked by these attachments. Please use the LCD monitor.

■ Wide Converter WC-DC52

Use this converter for taking wide-angle shots. The wide converter changes the focal length of the camera body's lens by a factor of 0.7x (the thread diameter is 52 mm).

■ Tele-converter TC-DC52A

This lens is used for taking telephoto shots. The lens changes the focal length of the camera body's lens by a factor of 1.75x. (the thread diameter is 52 mm)



It is not possible to attach a lens hood or filter to the wide converter or tele-converter.

■Close-up lens 250D (52mm)

This lens makes taking macro shots easy. In the macro mode, close-up shots can be taken when the distance from the front of the lens to the subject is 4 to 17cm (1.6 to 6.7 in.) at maximum wide angle and 14 to 17 cm (5.5 to 6.7 in.) at maximum telephoto.

Shooting area (during macro mode)

| | Distance from the front of the lens to the subject | Shooting area |
|----------------|--|-------------------------------|
| Wide angle end | 4 cm (1.6 in.) | 56 X 42 mm (2.2 X 1.7 in.) |
| Telephoto end | 14 cm (5.5 in.) | 39 X 29 mm (1.5 X 1.1 in.) |

■Conversion Lens Adapter LA-DC52F

This is a lens adapter required for attaching the wide converter, tele-converter and close-up lens (52 mm thread diameter).

Attaching a Lens

- 1 Be sure that the camera is turned off.**
- 2 Press the ring release button and hold it down, and turn the ring in the direction of the arrow.**

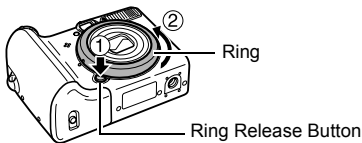

- 3** When the ○ mark on the camera and the ◻ mark on the ring are aligned, lift off the ring.

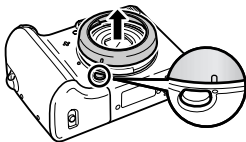

- 4** Align the ● mark on the conversion lens adapter with the ○ mark on the camera, and turn the adapter in the direction of the arrows as far as the ○ mark on the camera.

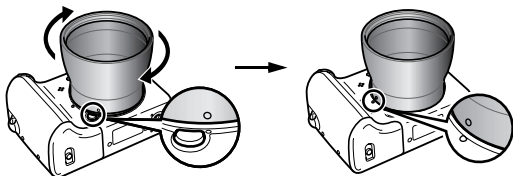

- To remove the conversion lens adapter, turn the adapter in the opposite direction with holding down the ring release button.

- 5** Set the lens on the adapter, and turn it in the indicated direction to attach it securely.





- Completely remove all dust and dirt from conversion lenses with a lens blower brush before use. The camera may focus on any dirt that remains.
- Be careful when handling the lenses since it is easy to get finger prints on them.
- Be careful not to drop the camera or adapter when removing the ring.
- When using these lens attachments, you should not shoot images in  mode. It will not be possible to use the PhotoStitch software from your computer to accurately stitch the images together.

Using an Externally Mounted Flash (Sold Separately)

High-Power Flash HF-DC1

This flash is used to supplement the camera's built-in flash when the subject is too far away for proper illumination. Use the following procedures to affix the camera and High-Power Flash to the supporting bracket.

Please read the instructions accompanying the flash along with this explanation.

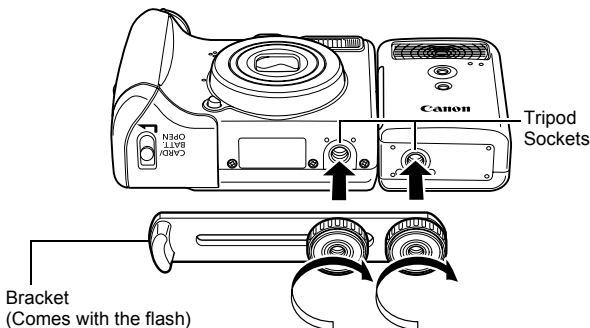



- When shooting in **M** mode, or when [Flash Adjust] in the **Tv** or **Av** modes is set to [Manual] (p. 65), the High-Power Flash will not fire.
- The flash charge time will lengthen as the battery charge gets weaker. Always set the power/mode switch to [OFF] when you finish using the flash.
- Be careful not to touch the flash window or sensor windows with your fingers while the flash is in use.
- The flash may fire if another flash is being used in close proximity.
- The High-Power Flash may not fire outdoors in daylight or when there are no reflective items.
- For continuous shooting, although the flash fires for the first shot, it does not fire for subsequent shots.
- Fasten the attachment screws securely so that they do not loosen. Failure to do so may lead to the dropping of the camera and flash resulting in damage to both.



- Before attaching the bracket to the flash, check that the lithium battery (CR123A or DL123) is installed.
- To illuminate the subjects properly, install the flash so that it is up against the side of the camera and parallel with the camera's front panel.
- A tripod can be used even when the flash is attached.

■ Batteries

● Charge becomes Severely Limited

If the battery usage time has considerably diminished, wipe the battery terminals well with a dry cloth. The terminals may be dirty from fingerprints.

● Usage in Cold Temperatures (Less than 0°C/32°F)

Get a spare generic lithium battery (CR123A or DL123). You are recommended to place the spare battery in your pocket to warm it up before switching it for the battery in the flash.

● Non-Use over Extended Periods

Leaving batteries in the High-Power Flash could allow the battery fluid to leak, damaging the product. Remove the batteries from the High-Power Flash and store them in a cool, dry place.

Replacing the Date Battery

If the Date/Time menu appears when the camera power is turned on, the date battery charge is low and the date and time settings have been lost. Please purchase a lithium coin battery (CR1220) and replace it as follows.

Please note that the first date battery may appear to expire relatively quickly after you purchase the camera. This is because it is installed in the camera at the point of manufacture, not when you make the purchase.



Be particularly careful to keep the date batteries out of the reach of children. Seek medical assistance immediately if a child swallows a battery since corrosive battery fluids can damage the stomach or intestinal walls.

- 1 Confirm that the camera is turned off.**
- 2 Slide the memory card slot / battery cover lock and open the cover.**
- 3 Hook your nail onto the date battery holder and lightly pull it up.**

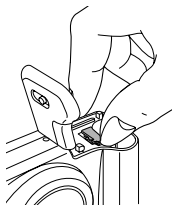

- 4 Remove the battery holder in the direction indicated by the arrow.**

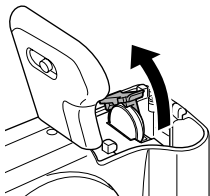

- 5 Remove the battery by pulling it up in the direction indicated by the arrow.**

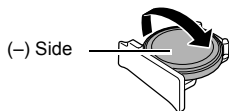

- 6 Insert a new battery with the (–) side facing up.**

- 7 Replace the battery holder and close the memory card slot/battery cover.**

- 8 When the Date/Time menu appears, set the date and time (*Basic Guide* p. 3).**



After purchasing the camera and turning on the power for the first time, although the Date/Time menu will appear, you do not need to replace the date battery.

Camera Care and Maintenance

Never use thinners, benzine, synthetic cleansers or water to clean the camera. These substances may distort or damage the equipment.

Camera Body

Gently wipe dirt off the camera body with a soft cloth or eyeglass lens wiper.

Lens

First use a lens blower brush to remove dust and dirt, then remove any remaining dirt by wiping the lens lightly with a soft cloth.



Never use synthetic cleansers on the camera body or lens. If dirt remains, contact the closest Canon Customer Support Help Desk as listed in the European Warranty System (EWS) Booklet.

Viewfinder and LCD Monitor

Use a lens blower brush to remove dust and dirt. If necessary, gently wipe with a soft cloth or an eyeglass lens wiper to remove stubborn dirt.



Never rub or press strongly on the LCD monitor. These actions may damage it or lead to other problems.

Specifications

All data is based on Canon's standard testing methods. Subject to change without notice.

PowerShot A540/A530

(W): Max. wide angle (T): Max. telephoto

| | |
|-------------------------|---|
| Camera Effective Pixels | : PowerShot A540: Approx. 6.0 million PowerShot A530: Approx. 5.0 million |
| Image Sensor | : PowerShot A540: 1/2.5-inch CCD (Total number of pixels: Approx. 6.2 million) PowerShot A530: 1/2.5-inch CCD (Total number of pixels: Approx. 5.3 million) |
| Lens | : 5.8 (W) – 23.2 (T) mm (35mm film equivalent: 35 (W) – 140 (T) mm) f/2.6 (W) – f/5.5 (T) |
| Digital Zoom | : PowerShot A540 Still images/Movies: Approx. 4.0x (Up to approx. 16x in combination with the optical zoom) PowerShot A530 Still images: Approx. 4.0x (Up to approx. 16x in combination with the optical zoom) Movies: Approx. 2.0x (Up to approx. 8.1x in combination with the optical zoom) |
| Optical Viewfinder | : Real-image zoom viewfinder |
| LCD Monitor | : PowerShot A540: 2.5-inch, low-temperature polycrystalline silicon TFT color LCD, approx. 85,000 pixels (Picture coverage 100%) PowerShot A530: 1.8-inch, low-temperature polycrystalline silicon TFT color LCD, approx. 77,000 pixels (Picture coverage 100%) |
| AF System | : TTL autofocus AF lock and Manual focus are available Focusing frame: 9-point (AiAF) / 1-point (AF) |

| | |
|---|---|
| Shooting Distance (From the front of the lens) | : PowerShot A540 Normal: 45 cm (1.5 ft.) – infinity Macro: 5 – 45 cm (W)/30 – 45 cm (T) (2.0 in. – 1.5 ft. (W)/12 in. – 1.5 ft. (T)) Manual focus: 5 cm (2.0 in.) – infinity (W)/ 30 cm (12 in.) – infinity (T) |
| | : PowerShot A530 Normal: 45 cm (1.5 ft.) – infinity Macro: 5 – 45 cm (W)/33 – 45 cm (T) (2.0 in – 1.5 ft. (W)/1.1 – 1.5 ft. (T)) Manual focus: 5 cm (2.0 in.) – infinity (W)/ 33 cm (1.1 ft.) – infinity (T) |
| Shutter | : Mechanical shutter + electronic shutter |
| Shutter Speeds | : 15 – 1/2000 sec. • The shutter speed varies according to the shooting mode. • Slow shutter speeds of 1.3 sec. or slower operate with noise reduction. |
| Metering System | : Evaluative, Center-weighted average or Spot* *Fixed to center |
| Exposure Compensation | : ± 2.0 stops in 1/3-stop increments |
| ISO Speed | : Auto*, ISO 80/100/200/400/800 equivalent * Camera automatically sets the optimal speed. |
| White Balance | : TTL auto, Daylight, Cloudy, Tungsten, Fluorescent, Fluorescent H or Underwater (PowerShot A540 only) or custom |
| Built-in Flash | : Auto*, on*, off * Red-eye reduction is available. |
| Flash Range | : Normal: 45 cm – 3.5 m (1.5 – 11 ft.) (W), 45 cm – 2.2 m (1.5 – 7.2 ft.) (T) Macro: PowerShot A540 30 - 45 cm (12 in. - 1.5 ft.) (W/T) PowerShot A530 33 – 45 cm (1.1 – 1.5 ft.) (W/T) (When ISO speed is set to AUTO.) |

| | |
|---|--|
| Flash Exposure Compensation | : ± 2.0 stops in 1/3-stop increments |
| Shooting Modes | : Auto Creative zone: Program, Shutter-speed priority (PowerShot A540 only), Aperture priority (PowerShot A540 only), Manual Image zone: Portrait, Landscape, Night scene, Special Scene ¹ , Stitch assist and Movie ² ¹ Night Snapshot, Kids&Pets, Indoor, Foliage, Snow, Beach, Fireworks, Underwater (PowerShot A540 only), Color Swap and Color Accent. ² Standard, Fast Frame Rate (PowerShot A540 only), Compact, Color Accent and Color Swap. |
| Continuous Shooting | : PowerShot A540: Approx. 2.3 shots/sec. (Large/Fine mode) PowerShot A530: Approx. 2.1 shots/sec. (Large/Fine mode) |
| Self-timer | : Activates shutter after an approx. 10-sec./ approx. 2-sec. delay, Custom Timer |
| Recording Media | : SD memory card/MultiMediaCard This camera has been tested with memory cards through 2 GB. All memory card functions cannot be guaranteed. |
| File Format | : Design rule for camera file system and DPOF compliant |
| Data Type (Still images) | : Exif 2.2 (JPEG)* ¹ Sound Memo: WAVE (monaural) |
| (Movies) | : AVI (Image data: Motion JPEG; Audio data: WAVE (monaural)) |
| Compression | : Superfine, Fine, Normal |
| Number of (Still images) Recording Pixels | : PowerShot A540: Large: 2816 x 2112 pixels Medium 1: 2272 x 1704 pixels Medium 2: 1600 x 1200 pixels Small: 640 x 480 pixels Postcard Date Imprint: 1600 x 1200 pixels Widescreen: 2816 x 1584 pixels |

: PowerShot A530:
Large: 2592 x 1944 pixels
Medium 1: 2048 x 1536 pixels
Medium 2: 1600 x 1200 pixels
Small: 640 x 480 pixels
Postcard Date Imprint:
1600 x 1200 pixels
Widescreen: 2592 x 1456 pixels

(Movies) : PowerShot A540: Standard, Color Accent
and Color Swap:
640 x 480 pixels (30 frames/sec., 15 frames/sec.)
320 x 240 pixels (30 frames/sec., 15 frames/sec.)
Recording can continue until the memory
card is full* (can record up to a maximum of
1GB at one time)**.
Fast Frame Rate: (can record for 1 min.)
320 x 240 pixels (60 frames/sec.)
Recording can continue until the memory
card is full* (can record up to a maximum of
1GB at one time)**.
Compact: (can record for 3 min.)
160 x 120 pixels (15 frames/sec.)

PowerShot A530: Standard, Color Accent
and Color Swap:
640 x 480 pixels (10 frames/sec.)
320 x 240 pixels (20 frames/sec.)
Recording can continue until the memory
card is full* (can record up to a maximum of
1GB at one time)**.
Compact: (can record for 3 min.)
160 x 120 pixels (15 frames/sec.)

: * Using super high-speed memory cards
(SDC-512 MSH recommended).
** Even if the clip size has not reached 1GB,
recording will stop at the moment the clip
length reaches 1 hour. Depending on the
volume and data writing speed of the
memory card, recording will stop after one
hour of continuous recording even if the
recorded data volume has not reached 1GB.

| | |
|------------------------------------|---|
| Playback Modes | : Single (histogram displayable), Index (9 thumbnail images), Magnified (approx. 10x (max.) in LCD monitor, advance or reverse through magnified images possible), Jump (it is possible to jump to every tenth or hundredth image, to the first image of each shooting date, to the first image in each folder, or to movies. In index playback mode, it displays 9 images at once.), Sound memos (up to 1 min.), Auto Play or Movie (edit/slow motion play back possible). |
| Direct Print | : <i>PictBridge</i> compliant, and <i>Canon Direct Print</i> and <i>Bubble Jet Direct</i> compatible |
| My Camera Settings | : Start-up image, start-up sound, operation sound, self-timer sound, and shutter sound. |
| Interface | : USB 2.0 Hi-Speed (mini-B), PTP (Picture Transfer Protocol) Audio/Video output (NTSC or PAL selectable, monaural audio) |
| Power Source | : 2 AA-size alkaline batteries 2 AA-size rechargeable NiMH batteries NB4-300 (sold separately) AC Adapter Kit ACK800 (sold separately) |
| Operating Temperatures | : 0 – 40 °C (32 – 104 °F) |
| Operating Humidity | : 10 – 90% |
| Dimensions (excluding protrusions) | : 90.4 x 64.0 x 43.2 mm (3.56 x 2.52 x 1.70 in.) |
| Weight (camera body only) | : PowerShot A540: Approx. 180 g (6.35 oz.) PowerShot A530: Approx. 170 g (6.00 oz.) |

*1 This digital camera supports Exif 2.2 (also called "Exif Print"). Exif Print is a standard for enhancing the communication between digital cameras and printers. By connecting to an Exif Print-compliant printer, the camera's image data at the time of shooting is used and optimized, yielding extremely high quality prints.

Battery Capacity

| | Number of Images Shot | | Playback Time |
|--|---|---------------------|-----------------|
| | LCD Monitor On (Based on the CIPA standard) | LCD Monitor Off | |
| AA-size Alkaline Batteries (included with the camera) | Approx. 90 images | Approx. 600 images | Approx. 5 hours |
| AA-size NiMH Batteries (NB-3AH (fully charged)) | Approx. 360 images | Approx. 1000 images | Approx. 7 hours |

- The actual figures will vary according to the shooting conditions and settings.
- Movie data is excluded.
- At low temperatures, the battery performance may diminish and the low battery icon may appear very rapidly. In these circumstances, the performance can be improved by warming the battery in a pocket before use.

Test Conditions

Shooting: Normal temperature (23°C ±2°C/73°F ±3.6°F), normal relative humidity (50% ±20%), alternating wide angle end and telephoto end shots at 30 second intervals with the flash fired once every two shots and the camera power turned off after every tenth shot. Power is left off for a sufficient amount of time*, then the power is turned back on and the testing procedure is repeated.

• A Canon-brand memory card is used.

* Until the battery returns to normal temperature

Playback: Normal temperature (23°C ±2°C/73°F ±3.6°F), normal relative humidity (50% ±20%), continuous playback at 3 seconds per image.





















See *Battery Handling Precautions* (p. 102).

Memory Cards and Estimated Capacities

■ PowerShot A540

☐: Card included with the camera

| Recording Pixels | Compression | 16MB | SDC-128M | SDC-512MSH |
|--|--|------|----------|------------|
| L (Large) 2816 x 2112 pixels |  | 5 | 45 | 176 |
| |  | 8 | 75 | 292 |
| |  | 19 | 156 | 603 |
| M1 (Middle 1) 2272 x 1704 pixels |  | 7 | 61 | 237 |
| |  | 13 | 109 | 425 |
| |  | 26 | 217 | 839 |
| M2 (Middle 2) 1600 x 1200 pixels |  | 14 | 121 | 471 |
| |  | 26 | 217 | 839 |
| |  | 50 | 411 | 1590 |
| S (Small) 640 x 480 pixels |  | 56 | 460 | 1777 |
| |  | 88 | 711 | 2747 |
| |  | 138 | 1118 | 4317 |
|  (Postcard Date Imprint Mode) 1600 x 1200 pixels |  | 26 | 217 | 839 |
| W (Widescreen) 2816 x 1584 pixels |  | 7 | 60 | 235* |
| |  | 12 | 101 | 392 |
| |  | 25 | 205 | 794 |

-  Capable of smooth continuous shooting (p. 34) (* Only available when card has been formatted with a low level format).
- This reflects standard shooting criteria established by Canon. Actual results may vary according to the subject and shooting conditions.

■ PowerShot A530

: Card included with the camera















| Recording Pixels | Compression | 16MB | SDC-128M | SDC-512MSH |
|--|-------------|------|----------|------------|
| L (Large) 2592 x 1944 pixels | S | 5 | 49 | 190* |
| | | 10 | 87 | 339 |
| | | 21 | 173 | 671 |
| M1 (Middle 1) 2048 x 1536 pixels | S | 9 | 76 | 295 |
| | | 16 | 136 | 529 |
| | | 33 | 269 | 1041 |
| M2 (Middle 2) 1600 x 1200 pixels | S | 14 | 121 | 471 |
| | | 26 | 217* | 839 |
| | | 50 | 411 | 1590 |
| S (Small) 640 x 480 pixels | S | 56 | 460 | 1777 |
| | | 88 | 711 | 2747 |
| | | 138 | 1118 | 4317 |
| (Postcard Date Imprint Mode) 1600 x 1200 pixels | | 26 | 217* | 839 |
| W (Widescreen) 2592 x 1456 pixels | S | 7 | 64 | 251 |
| | | 14 | 118 | 457 |
| | | 28 | 229 | 888 |

- Capable of smooth continuous shooting (p. 34) (*Only available when card has been formatted with a low level format).
- This reflects standard shooting criteria established by Canon. Actual results may vary according to the subject and shooting conditions.

Movie

■PowerShot A540











: Card included with the camera

| | Recording Pixels | Frame Rate | SDC-16M | SDC-128M | SDC-512MSH |
|---|--|---|-------------------|--------------------|--------------------|
|  Standard |  640 x 480 pixels |  | 7 sec. | 1 min. 4 sec. | 4 min. 9 sec. |
|  Color Accent | |  | 15 sec. | 2 min. 7 sec. | 8 min. 14 sec. |
|  Color Swap |  320 x 240 pixels |  | 22 sec. | 3 min. 1 sec. | 11 min. 42 sec. |
| | |  | 43 sec. | 5 min. 55 sec. | 22 min. 53 sec. |
|  Fast Frame Rate |  320 x 240 pixels |  | 11 sec. | 1 min. 32 sec. | 5 min. 59 sec. |
|  Compact |  160x 120 pixels |  | 1 min. 47 sec. | 14 min. 29 sec. | 55 min. 57 sec. |

* Maximum movie clip length at : 1 min., at : 3 min. The figures indicate the maximum continuous recording time.

■PowerShot A530

: Card included with the camera

| | Recording Pixels | Frame Rate | SDC-16M | SDC-128M | SDC-512MSH |
|--|--|---|-------------------|--------------------|--------------------|
|  Standard |  640 x 480 pixels |  | 23 sec. | 3 min. 10 sec. | 12 min. 16 sec. |
|  Color Accent | |  | 33 sec. | 4 min. 29 sec. | 17 min. 21 sec. |
|  Color Swap |  320 x 240 pixels |  | 33 sec. | 4 min. 29 sec. | 17 min. 21 sec. |
|  Compact |  160x 120 pixels |  | 1 min. 47 sec. | 14 min. 29 sec. | 55 min. 57 sec. |



















* Maximum movie clip length at : 3 min. The figures indicate the maximum continuous recording time.











Image Data Sizes (Estimated)

| Recording Pixels | | Compression | | |
|------------------|--------------------------------------|---|---|---|
| | |  |  |  |
| L | PowerShot A540 2816 x 2112 pixels | 2720 KB | 1620 KB | 780 KB |
| | PowerShot A530 2592 x 1944 pixels | 2503 KB | 1395 KB | 695 KB |
| M1 | PowerShot A540 2272 x 1704 pixels | 2002 KB | 1116 KB | 556 KB |
| | PowerShot A530 2048 x 1536 pixels | 1602 KB | 893 KB | 445 KB |
| M2 | 1600 x 1200 pixels | 1002 KB | 558 KB | 278 KB |
| S | 640 x 480 pixels | 249 KB | 150 KB | 84 KB |
| W | PowerShot A540 2816 x 1584 pixels | 2026 KB | 1210 KB | 585 KB |
| | PowerShot A530 2592 x 1456 pixels | 1890 KB | 1038 KB | 519 KB |

■ PowerShot A540

| | Recording Pixels | Frame Rate | File size |
|---|--|--|--------------|
|  Standard |  640 x 480 pixels |  30 | 1920 KB/sec. |
| | |  15 | 960 KB/sec. |
|  Color Accent |  320 x 240 pixels |  30 | 660 KB/sec. |
| | |  15 | 330 KB/sec. |
|  Fast Frame Rate |  320 x 240 pixels |  60 | 1320 KB/sec. |
|  Compact |  160 x 120 pixels |  15 | 120 KB/sec. |

■ PowerShot A530

| | Recording Pixels | Frame Rate | File size |
|--|--|---|-------------|
|  Standard |  640 x 480 pixels |  | 660 KB/sec. |
|  Color Accent |  320 x 240 pixels |  | 440 KB/sec. |
|  Color Swap | | | |
|  Compact |  160 x 120 pixels |  | 120 KB/sec. |

MultiMediaCard

| | |
|------------|---|
| Interface | Compatible with MultiMediaCard standards |
| Dimensions | 32.0 x 24.0 x 1.4 mm (1.3 x 0.9 x 0.06 in.) |
| Weight | Approx. 1.5 g (0.05 oz.) |

SD Memory Card

| | |
|------------|--|
| Interface | Compatible with SD memory card standards |
| Dimensions | 32.0 x 24.0 x 2.1 mm (1.3 x 0.9 x 0.1 in.) |
| Weight | Approx. 2 g (0.07 oz.) |

NiMH Battery NB-3AH

(Supplied with the separately sold NiMH Battery NB4-300 set or the Battery and Charger Kit CBK4-300)

| | |
|------------------------|--|
| Type | AA-size rechargeable nickel metal hydride battery |
| Nominal Voltage | 1.2 V DC |
| Typical Capacity | 2500 mAh (min.: 2300 mAh) |
| Cycle Life | Approx. 300 times |
| Operating Temperatures | 0 – 40°C (32 – 104°F) |
| Dimensions | Diameter: 14.5 mm (0.6 in.) Length: 50 mm (2.0 in.) |
| Weight | Approx. 30 g (1.1 oz.) |

Battery Charger CB-5AH/CB-5AHE

(Supplied with the separately sold Battery and Charger Kit CBK4-300)

| | |
|------------------------|---|
| Rated Input | 100 – 240 V AC (50/60 Hz), 16 - 21 VA |
| Rated Output | 565 mA* ¹ , 1275 mA* ² |
| Charging Time | Approx. 4 hours 40 min.* ¹ , approx. 2 hours* ² |
| Operating Temperatures | 0 – 35°C (32 – 95°F) |
| Dimensions | 65.0 x 105.0 x 27.5 mm (2.6 x 4.1 x 1.1 in.) |
| Weight (body only) | CB-5AH: Approx. 95 g (3.4 oz.) CB-5AHE: Approx. 97 g (3.4 oz.) |

*¹ When charging four NB-3AH batteries

*² When charging two NB-3AH batteries loaded one on each side of the battery charger

Compact Power Adapter CA-PS800

(Included with the separately sold AC Adapter Kit ACK800)

| | |
|------------------------|---|
| Rated Input | 100 – 240 V AC (50/ 60 Hz) 0.16 A (100 V) – 0.11 A (240 V) |
| Rated Output | 3.15 V DC, 2.0 A |
| Operating Temperatures | 0 – 40°C (32 – 104°F) |
| Dimensions | 42.6 x 104.0 x 31.4 mm (1.7 x 4.1 x 1.2 in.) |
| Weight | Approx. 180 g (6.3 oz.) (excluding power cord) |

PowerShot A540 only**Wide Converter WC-DC52 (Sold Separately)**

| | |
|--|--|
| Magnification | Approx. 0.7x |
| Focusing Range (from front of lens) | Approx. 21 cm (8.3 in.) – infinity (W)*1 |
| Thread Diameter | 52 mm standard filter thread*2 |
| Dimensions | Diameter: 58.0 mm (2.3 in.) Length: 30.5 mm (1.2 in.) |
| Weight | Approx. 74 g (2.6 oz.) |

Tele-converter TC-DC52A (Sold Separately)

| | |
|--|--|
| Magnification | Approx. 1.75x |
| Focusing Range (from front of lens) | Approx. 1.4 m (4.6 ft.) – infinity (T)*1 |
| Thread Diameter | 52 mm standard filter thread*2 |
| Dimensions | Diameter: 55.2 mm (2.2 in.) Length: 46.7 mm (1.8 in.) |
| Weight | Approx. 86 g (3.0 oz.) |

(W) : Max. wide angle (T) : Max. telephoto

*1 When mounted on PowerShot A540

*2 Conversion Lens Adapter LA-DC52F is required when mounted on PowerShot A540

Close-up Lens 250D 52 mm (Sold Separately)

| | |
|--|--|
| Focusing Range (from front of lens) | Normal: 17 – 25 cm (6.7 – 9.8 in.) (W / T) Macro: 4 – 17 cm (1.6 – 6.7 in.) (W / T) |
| Thread Diameter | 52 mm standard filter thread*2 |
| Dimensions | Diameter: 54 mm (2.1 in.) Length: 10.2 mm (0.4 in.) |
| Weight | Approx. 55 g (1.9 oz.) |

Conversion Lens Adapter LA-DC52F (Sold Separately)

| | |
|-----------------|--|
| Thread Diameter | 52 mm standard filter thread |
| Dimensions | Diameter: 55.6 mm (2.2 in.) Length: 39.1 mm (1.5 in.) |
| Weight | Approx. 14 g (0.5 oz.) |

(W) : Max. wide angle (T) : Max. telephoto

*1 When mounted on PowerShot A540

*2 Conversion Lens Adapter LA-DC52F is required when mounted on PowerShot A540

INDEX

A

- AC Adapter Kit ACK800 108
- AF Frame 16, 49
- AF Lock 50
- AF-assist Beam 24, 92
- AiAF 24, 49
- Auto Play 80
- Auto Rotate Function 67
- AV Cable 88

B

- Battery
 - Battery Capacity 122
 - Charging 106
 - Handling 102
 - Installing *Basic 1*

C

- Color Accent Mode 61
- Color Swap Mode 62
- Compression 31, 32
- Continuous Shooting 34
- Create Folder 68
- Creative Zone *Basic 7*
- Custom White Balance 56

D

- Date/Time 26, *Basic 3*
- DIGITAL Terminal ... 12, *Basic 19*
- Digital Zoom 33
- Direct Transfer *Basic 22*
- Distance Units 27
- Downloading Images to
 - a Computer *Basic 16*
- DPOF Print Order
 - Print Style 85
 - Selecting Images 83
- DPOF Transfer Order 86

E

- Erasing
 - All Images 82
 - Single Images *Basic 11*
- Exposure 54

F

- File Number 17, 70, 85
- Flash *Basic 8*
- Focus
 - Lock 50
 - Manual 51
- Frame Rate 41, 42
- FUNC./SET 14, 22

G

- Grid Line 16, 25

H

- HF-DC1 112
- Histogram 19

I

- Image Data Sizes (Estimated)
 - 126
- Image Zone *Basic 5*
- Index Playback 73
- Indicator 20
- Interface Cable *Basic 14, 19*
- ISO Speed 65

J

- Jump (Image Search) 74

L

- Landscape *Basic* 5
- Language 27, *Basic* 3
- LCD Monitor
 - Information Displayed 16
 - Night Display 15
 - Using the LCD Monitor 15

Lens

- Conversion Lens Adapter
 - 110
- Tele-converter 109
- Wide Converter 109

M

- Macro *Basic* 10
- Magnifying 72
- Maintenance 116
- Manual Exposure 47
- Manual Focus 51, 52
- Memory Card
 - Estimated Capacities 123
 - Formatting 105
 - Handling 104
 - Inserting *Basic* 1
- Menu
 - FUNC. Menu 24
 - 24
 - Menus and Settings 22
 - My Camera Menu 23, 28
 - Play Menu 25
 - Print Menu 23, 25
 - Rec. Menu 23, 24
 - Rec., Play, Set up and
 - My Camera Menu 23
 - Set up Menu 23, 26
- Messages 99
- Metering Modes 53
- MF-Point Zoom 24, 51
- Mode Switch 14, *Basic* 3, 4

Movie

- Editing 76
- Playback 75
- Shooting 39
- Viewing 75
- Mute 26
- My Colors 58, *Basic* 7

N

- Night scene *Basic* 6

P

- Playback *Basic* 11
- Portrait *Basic* 5
- Postcard Date Imprint Mode ... 35
- Power Button 14, *Basic* 4
- Power Saving 21, 26
- Print/Share Button ... 14, *Basic* 14
- Printing 83, *Basic* 14
- Protect 81

R

- Recording Pixels 16, 32, 42
- Red-Eye Reduction *Basic* 8
- Reset All 29
- Review 24, *Basic* 5
- Rotate 78

S

- Save Original 64
- Self-Timer 37
- Shooting Mode
 - Auto *Basic* 5
 - Creative Zone *Basic* 7
 - Functions Available 135
 - Image Zone *Basic* 5
- Shutter Button 14
 - Fully *Basic* 4
 - Halfway *Basic* 4

| | |
|-------------------------------|--------------------|
| Shutter Speed | 45 |
| Smooth Continuous Shooting .. | 34 |
| Sound Memo | 79 |
| Special Scene Mode | <i>Basic</i> 6 |
| Spot AE Point Frame | 16 |
| Stitch Assist | 43, <i>Basic</i> 7 |
| System Requirements ... | <i>Basic</i> 17 |

T

| | |
|-----------------------|-----------------------------|
| Telephoto | 33, 109, <i>Basic</i> 8, 10 |
| Troubleshooting | 89 |

V

| | |
|------------------------|------------|
| Video Output System .. | 88, 96, 97 |
|------------------------|------------|

W

| | |
|---------------------|--------------------|
| White Balance | 55 |
| Wide Angle | <i>Basic</i> 8, 10 |
| Wrist Strap | 13 |

Z

| | |
|------------|--------------------|
| Zoom | 33, <i>Basic</i> 8 |
|------------|--------------------|

Disclaimer

- While every effort has been made to ensure that the information contained in this guide is accurate and complete, no liability can be accepted for any errors or omissions.
- Canon reserves the right to change the specifications of the hardware and software described herein at anytime without prior notice.
- No part of this guide may be reproduced, transmitted, transcribed, stored in a retrieval system, or translated into any language in any form, by any means, without the prior written permission of Canon.
- Canon makes no warranties for damages resulting from corrupted or lost data due to a mistaken operation or malfunction of the camera, the software, SD memory cards (SD cards), personal computers, peripheral devices, or use of non-Canon SD cards.

Trademark Acknowledgments

- Macintosh, Mac OS and QuickTime are trademarks of Apple Computer Inc., registered in the United States and/or other countries.
- Microsoft® and Windows® are either registered trademarks or trademarks of Microsoft Corporation in the United States and/or other countries.
- SD is a trademark.
- Other names and products not mentioned above may be registered trademarks or trademarks of their respective companies.

Functions Available in Each Shooting Mode

The following chart shows the functions and settings available in each shooting mode.

| Function | | AUTO | | | | SCN | | | P | PowerShot A540 only | | | Ref. Page |
|------------------------------------|----------------------------|----------|---|---|---|-----|--------------------|-----------------|-----------------|---------------------|---|---|----------------------|
| | | | | | | | | | Tv | Av | M | | |
| Recording Pixels | Large | | ● | ● | ● | ● | ● | ▲ | ● | ● | ● | ● | p. 32, 42 |
| | Medium 1 | | ○ | ○ | ○ | ○ | ○ | ▲ | ○ | ○ | ○ | ○ | |
| | Medium 2 | | ○ | ○ | ○ | ○ | ○ | ▲ | ○ | ○ | ○ | ○ | |
| | Small | | ○ | ○ | ○ | ○ | ○ | ▲ | ○ | ○ | ○ | ○ | |
| | Postcard | | ○ | ○ | ○ | ○ | ○ | — | — | ○ | ○ | ○ | |
| | Wide-screen | | ○ | ○ | ○ | ○ | ○ | — | — | ○ | ○ | ○ | |
| Compression | Movie | | — | — | — | — | — | ○ ¹⁾ | — | — | — | — | |
| | Super Fine | | ○ | ○ | ○ | ○ | ○ | ▲ | — | ○ | ○ | ○ | p. 32 |
| | Fine | | ● | ● | ● | ● | ● | ▲ | — | ● | ● | ● | |
| Normal | | ○ | ○ | ○ | ○ | ○ | ▲ | — | ○ | ○ | ○ | | |
| Frame Rate | | — | — | — | — | — | — | ○ ¹⁾ | — | — | — | — | p. 42 |
| Flash | Auto | | ● | ● | ○ | ● | — | — | ○ | — | — | — | Basic Guide p. 8 |
| | On | | — | ○ | ○ | ○ | ^{2),3)} ▲ | — | ○ | ○ | ○ | ○ | |
| | Off | | ○ | ○ | ● | ○ | ▲ | — | ● | ● | ● | ● | |
| Red-Eye Reduction | | | ○ | ○ | ○ | ○ | ○ ²⁾ ▲ | — | ○ | ○ | ○ | ○ | Basic Guide p. 8 |
| AF-assist Beam | | | ○ | ○ | ○ | ○ | ○ ²⁾ ▲ | ○ | ○ | ○ | ○ | ○ | p. 24 |
| Flash Adjust (PowerShot A540 only) | | | — | — | — | — | — | — | — | ○ | ○ | — | p. 65 |
| +/- (Flash) | | | — | ○ | ○ | ○ | — | ▲ | — | ○ | ○ | — | p. 66 |
| Flash Output | | | — | — | — | — | — | — | — | ○ | ○ | ○ | p. 66 |
| Drive Mode | Single Shot | | ● | ● | ● | ● | ● | ▲ | ● | ● | ● | ● | — |
| | Continuous Shooting | | — | ○ | ○ | ○ | ○ ²⁾ | — | — | ○ | ○ | ○ | p. 34 |
| | 10 sec., 2 sec. Self Timer | | ○ | ○ | ○ | ○ | ○ | ▲ | ○ | ○ | ○ | ○ | p. 37 |
| | Custom | | ○ | ○ | ○ | ○ | ○ ²⁾ | — | — | ○ | ○ | ○ | p. 37 |
| AF Frame | | | — | ○ | ○ | ○ | ○ ²⁾ | — | — | ○ | ○ | ○ | p. 49 |
| AF Lock | | | — | ○ | ○ | ○ | ○ ²⁾ | — | ○ | ○ | ○ | ○ | p. 50 |
| Manual Focus | | | — | ○ | ○ | ○ | ○ ²⁾ | — | ○ | ○ | ○ | ○ | p. 51 |
| MF-Point Zoom | | | — | ○ | ○ | ○ | ○ ²⁾ | — | — | ○ | ○ | ○ | p. 51 |
| Macro Mode | | | ○ | ○ | — | ○ | ○ ²⁾ | ○ | ○ | ○ | ○ | ○ | Basic Guide p. 10 |
| Digital Zoom | | | ○ | ○ | ○ | ○ | ○ ²⁾ | — | ○ ⁵⁾ | ○ | ○ | ○ | p. 33 |
| Exposure Compensation | | | — | ○ | ○ | ○ | ○ ²⁾ | ▲ | — | ○ | ○ | ○ | p. 54 |

| Function | | AUTO | | | | SCN | | | PowerShot A540 only | | | Ref. Page |
|------------------------------|----------------------|------------------|------------------|------------------|------------------|------------------|------------------|------------------|---------------------|----|---|-----------|
| | | | | | | | | | Tv | Av | M | |
| Metering System | Evaluative | - ⁽⁴⁾ | - ⁽⁴⁾ | - ⁽⁴⁾ | - ⁽⁴⁾ | - ⁽⁴⁾ | - ⁽⁴⁾ | ● | ● | ● | ● | p. 53 |
| | Center Weighted Avg. | - | - | - | - | - | - | ○ | ○ | ○ | ○ | |
| | Spot | - | - | - | - | - | - | - | ○ | ○ | ○ | |
| White Balance ⁽⁶⁾ | | - ⁽⁴⁾ | ○ | ○ | ○ | - ⁽⁴⁾ | △ | ○ | ○ | ○ | ○ | p. 55 |
| My Colors | | - | - | - | - | - ⁽⁴⁾ | △ | ○ ⁽⁷⁾ | ○ | ○ | ○ | p. 58 |
| ISO Speed | | - ⁽⁴⁾ | - ⁽⁴⁾ | - ⁽⁴⁾ | - ⁽⁴⁾ | - ⁽⁴⁾ | - ⁽⁴⁾ | ○ | ○ | ○ | ○ | p. 65 |
| Auto Rotate | | ○ | ○ | ○ | ○ | ○ | △ | - | ○ | ○ | ○ | p. 67 |
| Grid Lines | | ○ | ○ | ○ | ○ | ○ | - | ○ | ○ | ○ | ○ | p. 25 |

- Default setting ○ Setting available △ Setting can only be selected for the first image (▲: Default setting).
- (Shaded Area): Setting is retained even when the camera power is shut off.
- With the exception of the [Date/Time], [Language] and [Video System] settings, all the other menu settings and changes made with the camera buttons can be reset to the default values in a single operation (p. 29).

(1) The recording pixels and frame rates for the Movie mode (p. 42).

(2) The following functions cannot be set in the mode.

- The [Auto] and [On] setting for the flash
- Red-eye reduction function
- AF-assist beam
- AF frame selection (AF frame will be fixed to a single point at the center.)
- MF-Point zoom
- Macro mode
- AF lock
- Manual focus

The following functions cannot be set in the mode.

- Macro mode
 - AF frame selection (AF frame will be fixed to a single point at the center).
- The following settings cannot be accomplished for (color accent) and (color swap).

- Continuous Shooting
- Custom Self-timer
- Exposure Compensation
- Digital Zoom

(3) The default flash setting will be [Auto] in the , , , , , * modes, and [Flash off] in the , , , modes.

(4) Automatically set by the camera.

(5) Operation is possible during shooting (only during standard).

(6) Settings cannot be made when My Colors is set to or mode.

(7) In or modes, settings cannot be made.

*PowerShot A540 only



Canon