



KONICA MINOLTA

*D*IMAGE A200



 INSTRUCTION MANUAL

COLOR MODE

The color mode controls whether a still image is color or black and white as well as the color space. The color mode is set with the function button (p. 64). The live image on the monitors will reflect the selected color mode. For more on the color mode see page 68.



Natural Color and Embedded Adobe RGB - reproduces the colors in the scene faithfully.



Vivid Color - increases the saturation of the colors in the scene.

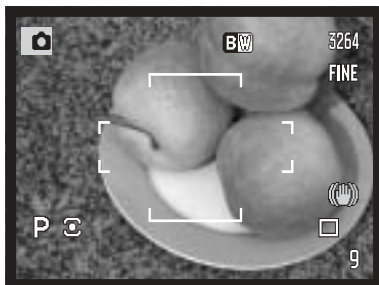

Black & White - produces monochrome images.

BEFORE YOU BEGIN

Thank you for purchasing this Konica Minolta digital camera. Please take the time to read through this instruction manual so you can enjoy all the features of your new camera.

Check the packing list before using this product. If any items are missing, immediately contact your camera dealer.

DiMAGE digital camera
Lithium-ion battery NP-800
Lithium-ion battery charger BC-900
Wireless remote control RC-D1
Neck strap NS-DG8000
Lens shade DLS-3
Lens cap LF-1349
Accessory shoe cap

AV cable AVC-500
USB cable USB-3
Ulead VideoStudio CD-ROM
DiMAGE Viewer CD-ROM
DiMAGE Viewer instruction manual
Camera instruction manual
Warranty card

This product is designed to work with accessories manufactured and distributed by Konica Minolta. Using accessories or equipment not endorsed by Konica Minolta may result in unsatisfactory performance or damage to the product and its accessories.

Only use the battery specified in this manual that are manufactured and distributed by Konica Minolta. Beware of counterfeit batteries; the use of these batteries will damage the product and may cause fire.

Konica Minolta is a trademark of Konica Minolta Holdings, Inc. DiMAGE is a trademark of Konica Minolta Photo Imaging, Inc. Apple, Macintosh, and Mac OS are registered trademarks of Apple Computer Inc. Microsoft and Windows are registered trademarks of the Microsoft Corporation. The official name of Windows is Microsoft Windows Operating System. Pentium is a registered trademark of the Intel Corporation. Microdrive is a trademark of Hitachi Global Storage Technologies. QuickTime is a trademark used under license. Adobe is a registered trademark of Adobe Systems Incorporated. All other brand and product names are trademarks or registered trademarks of their respective owners.

FOR PROPER AND SAFE USE

NP-800 LITHIUM-ION BATTERIES

This camera operates on a powerful lithium-ion battery. Misuse or abuse of the lithium-ion battery can cause damage or injury through fire, electric shock, or chemical leakage. Read and understand all warnings before using the battery.

DANGER

- Do not short, disassemble, damage, or modify the battery.
- Do not expose the battery to fire or high temperatures over 60°C (140°F).
- Do not expose the battery to water, or moisture. Water can corrode or damage the internal battery safety devices and cause the battery to overheat, ignite, rupture, or leak.
- Do not drop or subject the battery to strong impacts. Impacts can damage the internal battery safety devices and cause the battery to overheat, ignite, rupture, or leak.
- Do not store the battery near or in metallic products.
- Do not use the battery with any other products.
- Only use the specified charger. An inappropriate charger may cause damage or injury through fire or electric shock.
- Do not use a leaking battery. If fluid from the battery enters your eye, immediately rinse the eye with plenty of fresh water and contact a doctor. If fluid from the battery makes contact with your skin or clothing, wash the area thoroughly with water.
- Only use or charge the battery in an environment with ambient temperatures between 0° and 40°C (32° and 104°F). Only store the battery in an environment with ambient temperatures between -20° and 30°C (-4° and 86°F) and a humidity of 45% to 85% RH.

WARNING

- Tape over the lithium-ion battery contacts to avoid short-circuiting during disposal; always follow local regulations for battery disposal.
- If charging is not completed after the specified period elapses, unplug the charger and discontinue charging immediately.

GENERAL PRODUCT WARNINGS AND CAUTIONS

Read and understand the following warnings and cautions for safe use of the digital camera and its accessories.

WARNING

Using the remote control battery improperly can cause it to leak harmful solutions, overheat, or explode which may damage property or cause personal injury. Do not ignore the following warnings.

- Only use the remote-control battery specified in this manual.
 - Do not install the battery with the polarity (+/-) reversed.
 - Do not use the battery which shows wear or damage.
 - Do not expose the battery to fire, high temperatures, water, or moisture.
 - Do not attempt to recharge, short, or disassemble the battery.
 - Do not store the battery near or in metallic products.
 - Tape over the battery contacts to avoid short-circuiting during disposal; always follow local regulations for battery disposal.
-
- Only use the camera battery specified in this manual.
 - Only use the specified charger or AC adapter within the voltage range indicated on the unit. An inappropriate adapter or current may cause damage or injury through fire or electric shock.
 - Only use the charger power cord in the sales region for which it was designed. An inappropriate current may cause damage or injury through fire or electric shock.
 - Do not disassemble the camera or charger. Electric shock may cause injury if a high voltage circuit inside the product is touched.
 - Immediately remove the battery or unplug the AC adapter and discontinue use if the camera is dropped or subjected to an impact in which the interior, especially the flash unit, is exposed. The flash has a high voltage circuit which may cause an electric shock resulting in injury. The continued use of a damaged product or part may cause injuries or fire.

- Keep the batteries, memory card, or small parts that could be swallowed away from infants. Contact a doctor immediately if an object is swallowed.
- Store this product out of reach of children. Be careful when around children not to harm them with the product or parts.
- Do not fire the flash directly into the eyes. It may damage eyesight.
- Do not fire the flash at vehicle operators. It may cause a distraction or temporary blindness which may lead to an accident.
- Do not use the monitor while operating a vehicle or walking. It may result in injury or an accident.
- Do not use these products in a humid environment, or operate them with wet hands. If liquid enters these products, immediately remove the battery or unplug the product, and discontinue use. The continued use of a product exposed to liquids may cause damage or injury through fire or electric shock.
- Do not use these products near inflammable gases or liquids such as gasoline, benzene, or paint thinner. Do not use inflammable products such as alcohol, benzene, or paint thinner to clean these products. The use of inflammable cleaners and solvents may cause an explosion or fire.
- When unplugging the AC adapter or charger, do not pull on the power cord. Hold the plug when removing it from an outlet.
- Do not damage, twist, modify, heat, or place heavy objects on the AC adapter or charger cord. A damaged cord may cause damage or injury through fire or electric shock.
- If these products emit a strange odor, heat, or smoke, discontinue use. Immediately remove the battery taking care not to burn yourself as the battery may become hot with use. The continued use of a damaged product or part may cause injuries or fire.
- Take the product to a Konica Minolta service facility when repairs are required.
- Handling the cord on this product may expose you to lead, a chemical known to the State of California to cause cancer, and birth defects or other reproductive harm. Wash hands after handling.

CAUTION

- Do not use or store these products in a hot or humid environment such as the glove compartment or trunk of a car. It may damage the camera, charger, and battery which may result in burns or injuries caused by heat, fire, explosion, or leaking battery fluid.
- If the battery is leaking, discontinue use of the product.
- The camera, charger, and battery temperature rises with extended periods of use. Care should be taken to avoid burns.
- Burns may result if the memory card or battery is removed immediately after extended periods of use. Turn the camera off and wait for it to cool.
- Do not fire the flash while it is in contact with people or objects. The flash unit discharges a large amount of energy which may cause burns.
- Do not apply pressure to the LCD monitor. A damaged monitor may cause injury, and the liquid from the monitor may cause inflammation. If liquid from the monitor makes contact with skin, wash the area with fresh water. If liquid from the monitor comes in contact with the eyes, immediately rinse the eyes with plenty of water and contact a doctor.
- When using the AC adapter and charger, insert the plug securely into the electrical outlet.
- The rim of the lens hood can cause injury. Take care not to accidentally strike anyone with the camera when the lens hood is attached.
- Do not use electronic transformers or travel adapters with the charger. The use of these devices may cause a fire or damage the product.
- Do not use if the AC adapter or charger cord is damaged.
- Do not cover the AC adapter or charger. A fire may result.
- Do not obstruct access to the AC adapter or charger; this can hinder the unplugging of the units in emergencies.
- Unplug the AC adapter or charger when cleaning or not in use.

TABLE OF CONTENTS

Color mode	2
Before you begin	3
For proper and safe use	4
Names of parts	13
Getting up and running	16
Attaching the camera strap	16
Removing the lens cap	16
Attaching the lens hood	17
Charging the battery	18
Installing and changing the battery	19
Battery condition indicator	20
Auto power save	20
External power supplies (sold separately)	21
Inserting and changing a memory card	22
Turning on the camera	24
Handling the camera	24
Diopter adjustment	25
LCD monitor setup	26
Display-mode button	27
Setting the date and time	28
Setting the menu language	29
Basic recording	30
Setting the camera to record images automatically	30
Basic recording operation	30
Focus lock	32
Automatic monitor amplification	32
Focus signals	33
Special focusing situations	33
Using the built-in flash	34
Flash range - automatic operation	34
Camera-shake warning	35
Anti-shake system	36
Basic playback	37
Single-frame playback and histogram display	38
Viewing images and histogram	39
Rotating images	39
Deleting single images	39
Changing the Quick View & playback display	40

Enlarged playback	41
Advanced recording	42
Recording mode display	42
Display-information button	43
Focus-mode button.....	44
Manual focus and Flex Digital Magnifier	45
Changing AF-area modes.....	46
Spot AF areas.....	47
Flex Focus Point.....	48
Macro mode.....	49
Exposure lock	50
Exposure-mode dial.....	50
Program - P	51
Program shift - P/PA/Ps.....	51
Auto recording	52
Aperture priority - A.....	54
Shutter priority - S.....	55
Shutter-speed range and camera sensitivity (ISO)	55
Manual exposure - M.....	56
Bulb exposures.....	57
Digital Subject Programs.....	58
Exposure and flash compensation	59
White balance.....	60
Custom white balance calibration.....	62
Using the function button.....	64
Camera sensitivity - ISO.....	66
Flash range and camera sensitivity.....	67
Attaching an accessory flash unit.....	67
Color mode	68
About Adobe RGB	69
Flash modes	70
Metering modes	72
Filter	73
Color-saturation compensation.....	74
Contrast compensation.....	74

Using the drive-mode button	76
Self-timer	77
Recording with remote control	78
Setting up the camera for remote control	78
Using the remote control	79
Bracketing	80
Continuous advance	82
Recording menu	84
Navigating the recording-mode menu	84
Image size and image quality	86
About RAW image quality	88
Notes on image size and resolution	89
Spot AE area	90
Flash control	90
AEL button	92
Recording-mode reset	93
Sharpness	94
Date imprinting	95
Instant playback	96
Full-time AF	97
Direct Manual Focus	97
Memory - storing camera settings	98
Memory recall	99
DSP (Digital Subject Program) setup	100
Noise reduction	100
Monitor amplification	101
Digital zoom	102
A short guide to photography	103
About exposure and flash compensation	104
What is an Ev?	105
Light sources and color	105
Movie mode	106
Movie recording	106
Navigating the movie menu	107
Image size and frame rate	108
Movie mode	108
Movie reset	109
Notes on movie recording	109
Advanced playback	110
Viewing movies	110

Capturing a movie frame.....	111
Navigating the playback menu	112
Frame-selection screen	114
Delete	115
Format	116
View folder	116
Lock	117
Movie editing.....	118
Slide Show.....	120
Magnification setup.....	120
About DPOF	121
DPOF setup	121
Date imprint	122
Index print.....	122
Cancel print	123
Copy and E-mail Copy	123
Viewing images using the remote control	126
Changing the battery	127
Viewing images on a television	128
Setup menu	129
Opening the setup menu	129
Navigating the setup menu.....	130
Date and time setup	131
LCD brightness	132
Lens accessory.....	132
Video output	132
Transfer mode	133
Anti-shake.....	133
Delete confirmation.....	133
Language.....	134
Shortcut help	134
File number memory.....	136
Folder name	136
Select folder.....	137
New folder	137
Reset default	138
Audio signals	140
Focus signals.....	140
Shutter FX	141
Volume	141

Auto power save.....	141
Data-transfer mode	142
System requirements.....	142
Connecting the camera to a computer	143
Connecting to Windows 98 / 98 second edition	144
Automatic installation	144
Manual installation	145
QuickTime system requirements	147
VideoStudio system requirements.....	147
Auto power save (Data-transfer mode)	147
Memory card folder organization	148
Disconnecting the camera from the computer	150
Windows 98 / 98 second edition.....	150
Windows Me, 2000 Professional, and XP	150
Macintosh.....	151
Changing the memory card (data-transfer mode)	152
Removing the driver software - Windows.....	153
PictBridge	154
Notes on printing errors.....	155
Navigating the PictBridge menu	156
Troubleshooting.....	160
When using filters.....	162
About the lithium-ion battery charger cord	163
About PC Flash Adapter PCT-100.....	163
Wide-angle Converter ACW-100, Telephoto Converter ACT-100, Close-up Lens CL-49-200.....	164
Care and storage	164
Camera care.....	164
Cleaning.....	165
Storage.....	165
Operating temperatures and conditions	165
Memory card care and handling.....	166
Batteries.....	166
LCD monitor care	167
Copyright	167
Before important events or journeys	167
Questions and service.....	167
Technical specifications	168
Filter examples	171

NAMES OF PARTS

* This camera is a sophisticated optical instrument. Care should be taken to keep these surfaces clean. Please read the care and storage instructions in the back of this manual (p. 164).

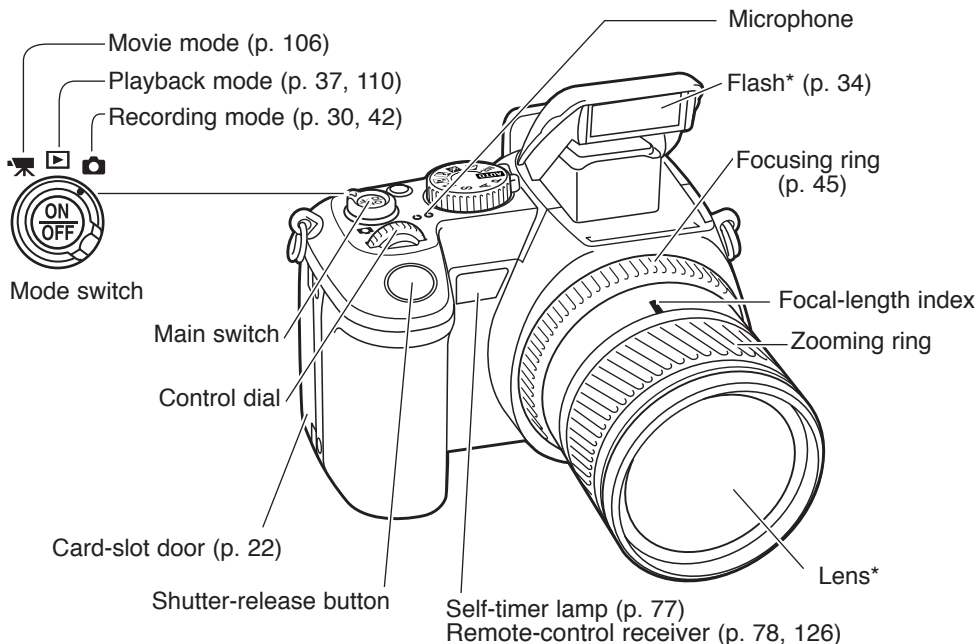

Camera Notes

The focal-length scale on the zooming ring is given in 35mm focal-length equivalents. The DiIMAGE Viewer software supplied with the camera can display the actual focal length used to capture the recorded image as well as the equivalent focal length in 35mm photography.

- Manual exposure (p. 56) **M**
- Shutter priority (p. 55) **S**
- Aperture priority (p. 54) **A**
- Program exposure (p. 51) **P**
- Auto recording (p. 52) **AUTO**

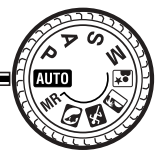

- MR** Memory recall (p. 99)
- Portrait subject program (p. 58)
- Sports action subject program (p. 58)
- Sunset subject program (p. 58)
- Night portrait subject program (p. 58)

Exposure-mode dial

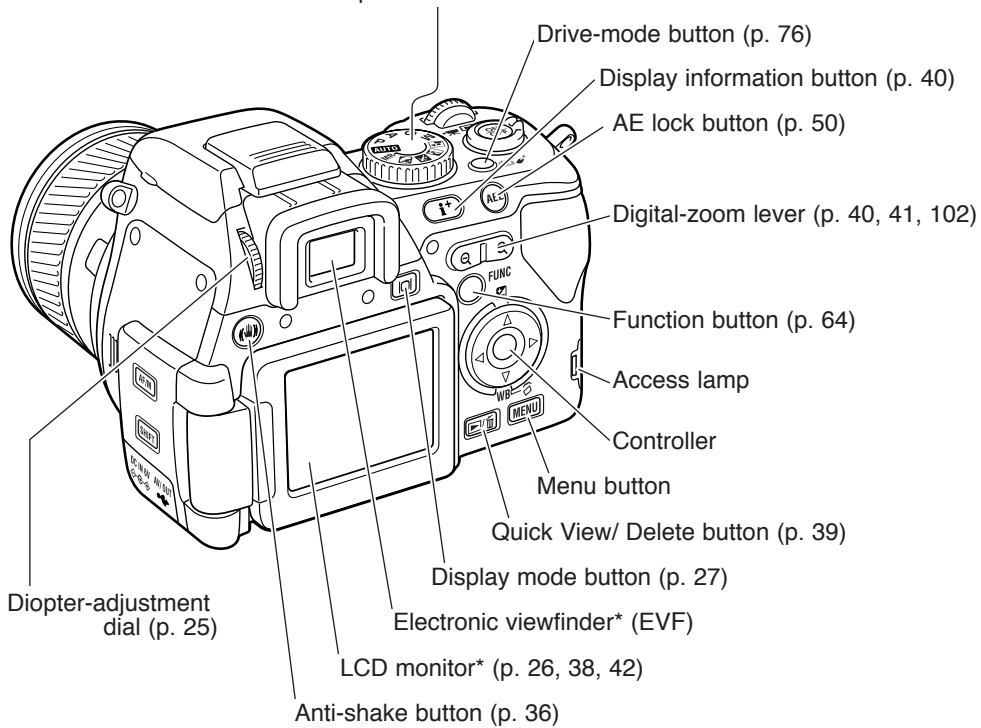

- Drive-mode button (p. 76)
- Display information button (p. 40)
- AE lock button (p. 50)
- Digital-zoom lever (p. 40, 41, 102)
- Function button (p. 64)
- Access lamp
- Controller
- Menu button
- Quick View/ Delete button (p. 39)

- Diopter-adjustment dial (p. 25)
- Anti-shake button (p. 36)

- Display mode button (p. 27)
- Electronic viewfinder* (EVF)
- LCD monitor* (p. 26, 38, 42)

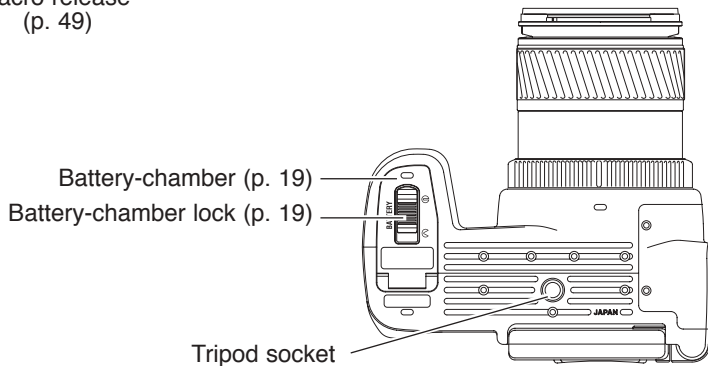
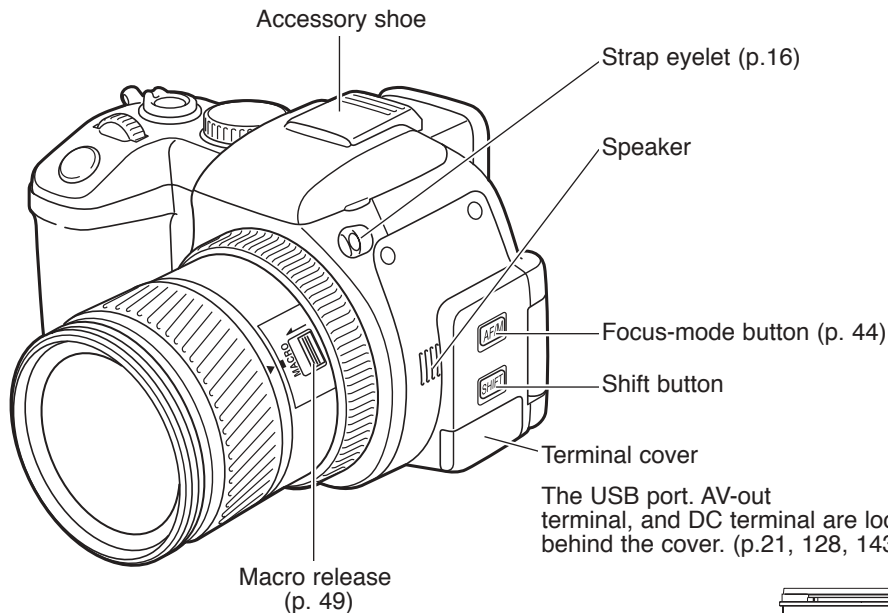

GETTING UP AND RUNNING

This section covers the preparation of the camera. This includes the changing of batteries and memory card as well as the use of external power supplies.

ATTACHING THE CAMERA STRAP

Attach the camera strap to the strap eyelets as shown. The tip of the strap should pass under the buckle (2).

Always keep the camera strap around your neck in the event that you drop the camera.

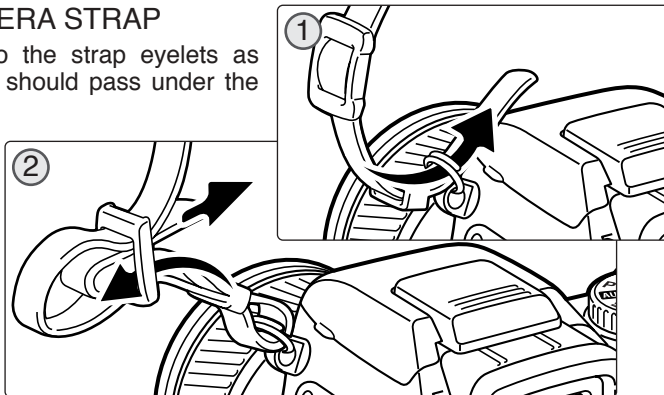

REMOVING THE LENS CAP

Using your thumb and index finger, pinch the inside or outside tabs of the lens cap to remove. When the camera is not in use, always replace the lens cap.

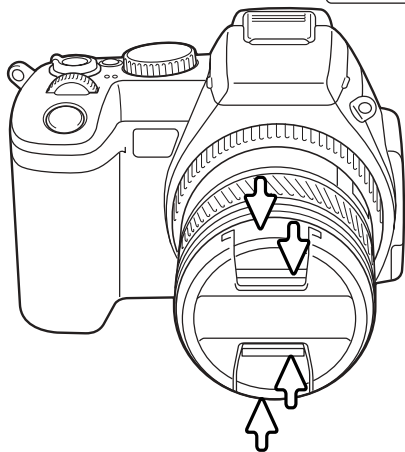

ATTACHING THE LENS HOOD

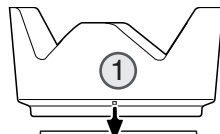

The lens hood is used to control stray light from entering the lens and causing flare. When using the camera under bright light, the use of the lens hood is recommended. The lens hood should not be used with the built-in flash as it can cause a shadow.

To mount the lens hood, align the rectangular dimple on the rim of the hood with the focal-length index on the top of the lens barrel (1).

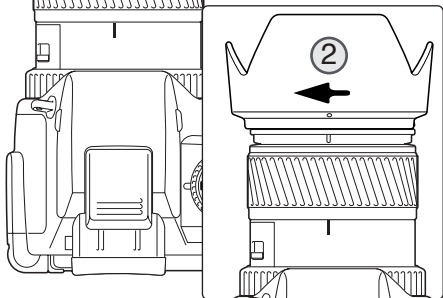

Slide the hood onto the end of the lens and turn it 90° clockwise until it clicks and the circular dimple is aligned with the focal-length index (2). When mounted correctly, the large petals of the lens hood should be to the top and bottom. Never force the lens hood. If it does not fit, check its orientation. To detach the lens hood, turn it 90° counterclockwise and remove.

The lens hood can be reverse mounted when the camera is not in use.

With one of the large petals to the top, slide the hood onto the end of the lens. Turn it 90° clockwise until it clicks into place.

The lens hood can be attached or removed with the lens cap on the camera. To detach the lens hood, turn it 90° counterclockwise and remove.

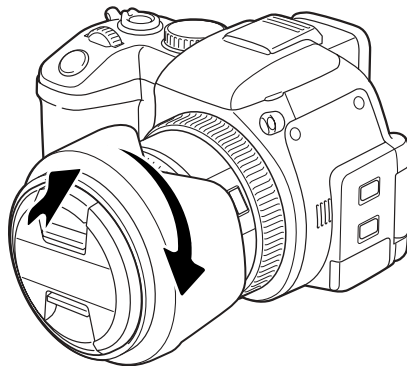

CHARGING THE BATTERY

Before the camera can be used, the lithium-ion battery must be charged. Before charging the battery, read the safety warnings on page 4 of this manual. Only recharge the battery with the supplied battery charger. The battery should be recharged before each shooting session. See page 166 for battery care and storage.

Plug the power cord into the side of the charger unit (1). Plug the other end of the cord into a live household outlet. The included AC cord is designed for the current of the sales region. Only use the cord in the region it was purchased. For more on the AC cable, see page 163.

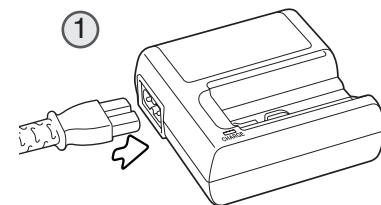

With the battery contacts down and toward the charger, slide the battery into the unit. If the battery does not slide all the way into the charger, check its orientation.

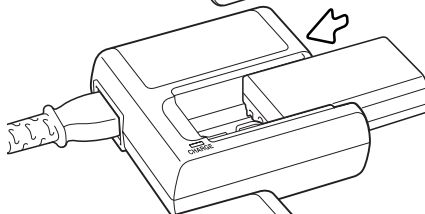

The indicator lamp (2) glows to show the battery is charging. The lamp goes out when the battery is charged. Charging time is approximately 90 minutes.

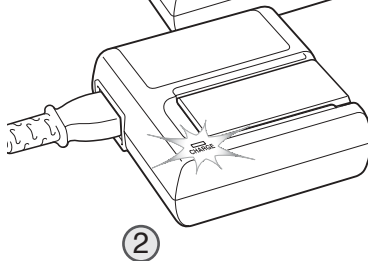

When the battery has been charged, remove it from the charger. Unplug the power cord from the outlet.

INSTALLING AND CHANGING THE BATTERY

This digital camera uses one NP-800 lithium-ion battery. Before using the battery, read the safety warnings on pages 4 of this manual. When replacing batteries, the camera should be off.

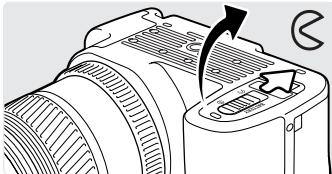

Open the battery-chamber door by sliding the battery-chamber lock to the open position.

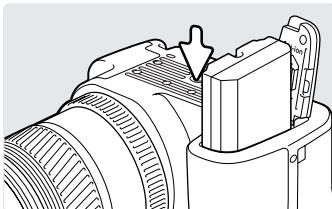

Insert the battery with the battery contacts first. Insert the battery so that it slides past the battery latch in the chamber. Push the battery into the chamber until the latch clicks into place.

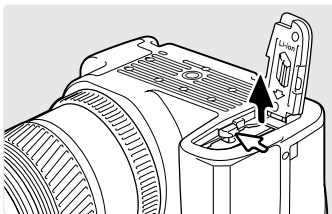

To remove a battery, slide the battery latch to the side of the battery chamber; the battery will spring out.

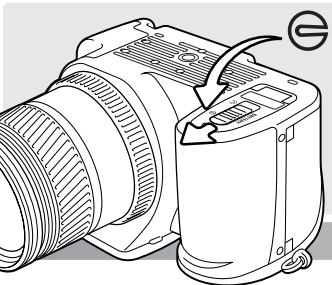

Close the battery-chamber door and slide the battery-chamber lock to the close position.

BATTERY CONDITION INDICATOR

This camera is equipped with an automatic battery-condition indicator. The monitor indicator will change from white to red when battery power is low.



Full-battery indicator - the battery is fully charged. This indicator is displayed when the camera is on.



Low-battery indicator - the battery is partially charged. The monitor will turn off while the flash is charging to save power.



Low-battery warning - battery power is very low. The battery should be recharged as soon as possible. This warning automatically appears and remains on the monitors until the battery is recharged. The monitor will turn off while the flash is charging to save power. If power falls below this level when the camera is on, the battery-exhausted message appears just before the camera shuts down. If the battery warning is displayed, movie recording, movie editing, and UHS continuous advance cannot be used.

AUTO POWER SAVE

To conserve battery power, the camera will turn off the monitors and unnecessary functions if an operation is not made within three minutes (auto power save). To restore power, press the shutter-release button partway down or press the main switch. The length of the auto-power-save period can be changed in section 3 of the setup menu (p. 141).

If an operation is not made within thirty minutes, the camera will shut down (auto power off). Press the main switch to restore power.

EXTERNAL POWER SUPPLIES (SOLD SEPARATELY)

The AC Adapter AC-11 allows the camera to be powered from an electrical household outlet. The AC Adapter is recommended when the camera is interfaced with a computer or during periods of heavy use. The included adapter power cord is designed for the current requirements of the sales region.

The External High-power Battery Pack Kit EBP-100 is a portable power source and significantly extends the operating time of the camera. The kit contains a high-power lithium-ion battery, holder, and charger. The battery, holder, and charger are also available separately.

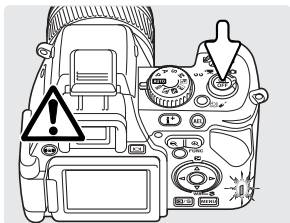

Always turn off the camera and confirm the access lamp is not lit before changing between power supplies.

Connect the power cord to the AC adapter unit.

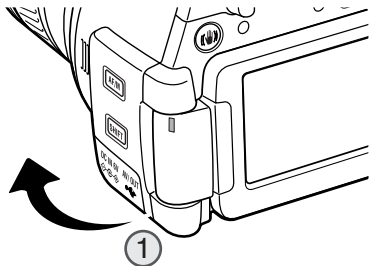

Remove the terminal cover from the right (1). The cover is attached to the body to prevent loss.

Insert the mini plug of the AC adapter or battery pack into the DC terminal (2).

Insert the AC adapter plug into an electrical outlet.

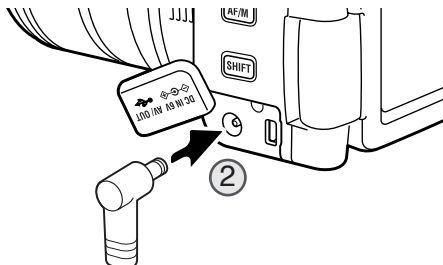

INSERTING AND CHANGING A MEMORY CARD

Always turn off the camera and confirm the access lamp is not lit before inserting or removing a memory card, otherwise the card may be damaged, and data lost.

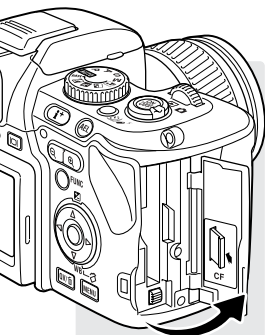
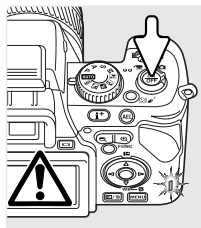

A memory card must be inserted for the camera to operate. If a card has not been inserted, a no-card warning will be displayed on the monitors. Type I and II CompactFlash cards and Microdrives are compatible with this camera. For memory card care and handling, see page 166.

Open the card-slot door in the direction indicated.

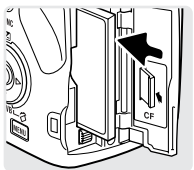

Insert a memory card all the way into the card slot. Insert the card so the face is toward the front of the camera. Always push the card in straight. Never force the card. If the card does not fit, check that it is oriented correctly.

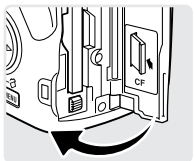

Close the card-slot door.

Accessory

The CompactFlash Adapter for SD Memory Cards SD-CF1 allows SD (Secure Digital) Memory Cards or MultiMediaCards to be used with this camera.

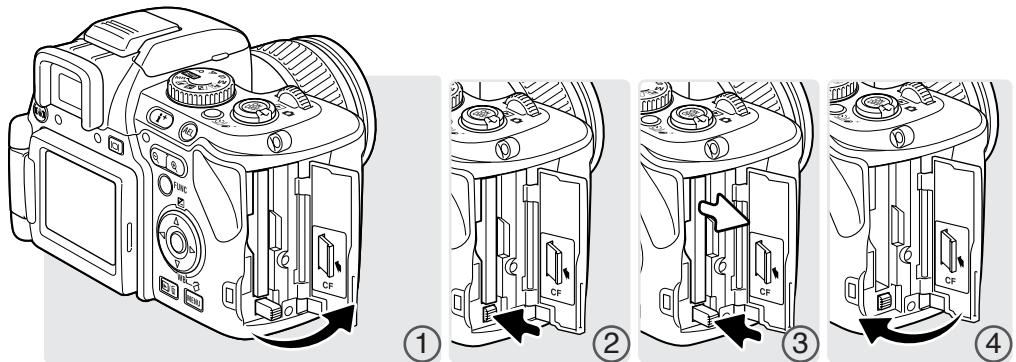

To eject a card, open the card-slot door (1), and press and release the card-eject lever to extend it (2).

Press the card-eject lever to eject the card (3). The card can now be pulled out. Take care when removing the card as it becomes hot with use. The card-eject lever should remain inside the camera body. If it extends, push it into the camera.

Insert a new memory card and close the card-slot door (4).

If the “Unable to use card. Format?” message appears, the card should be formatted with the camera. Using the left/right keys of the controller, select “Yes” to format the card. “No” closes the window without formatting the card; remove the unformatted card from the camera. Formatting erases all data on the memory card permanently. Depending on the memory card, formatting can take several minutes. A memory card can also be formatted in section 1 of the playback menu (p. 116). A memory card used in another camera may have to be formatted before being used.

If the card-error message appears, press the central button of the controller to close the window; check the Konica Minolta web site for the latest compatibility information:

North America: <http://www.konicaminolta.us/>
Europe: <http://www.konicaminoltasupport.com>

TURNING ON THE CAMERA

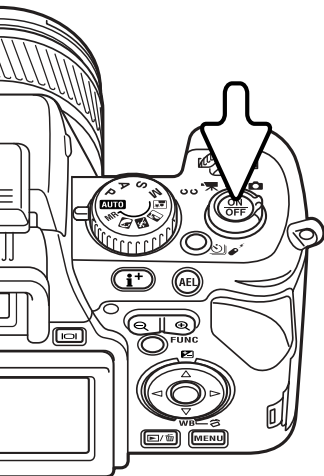

Press the main switch to turn on the camera. An audio signal sounds to indicate the power is turned on. The audio signal can be turned off with the setup menu (p. 140).

If the camera shuts down immediately after it is turned on, the battery power is low. See page 18 on how to charge the battery.

Press the main switch to turn the camera off.

HANDLING THE CAMERA

While using the electronic viewfinder (EVF) or LCD monitor, grip the camera firmly with your right hand while supporting the body with the palm of your left hand. Keep your elbows at your side and your feet shoulder-width apart to hold the camera steadily. See page 26 for LCD monitor setup.

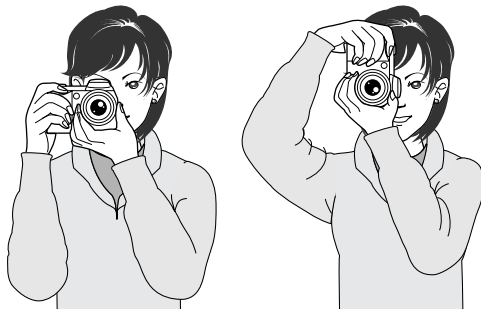

DIOPTER ADJUSTMENT

The EVF has a built-in diopter that can be adjusted between -5 to $+2$. While looking through the EVF, turn the diopter-adjustment dial until the viewfinder image is sharp.

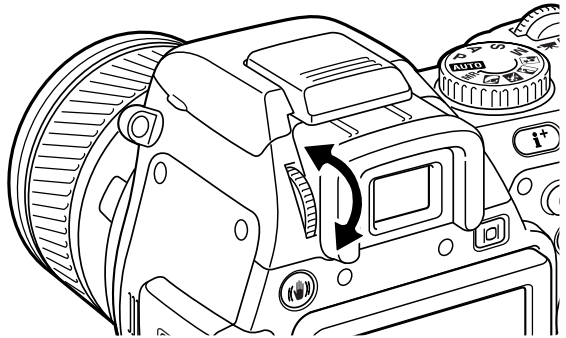

Konica Minolta History

On February 20th, 1962, John Glenn became the first American to orbit the Earth. On board his Friendship 7 spacecraft was a Minolta Hi-matic camera to record that historic event. The 4 hour, 55 minute, and 23 second flight orbited the Earth three times at an average speed of 28,000 kph (17,500 mph).

Mr. Glenn visited our Sakai camera factory in Japan on May 24th, 1963 to plant a palm tree to celebrate the occasion. The palm tree is still in the courtyard of the factory and stands over eight meters tall (26ft).

The camera? It was not lost. It is on display at the Smithsonian Institution's National Air and Space Museum in Washington D.C. This and other objects from John Glenn's Friendship 7 Mercury flight can be found in galley 210, "Apollo to the Moon."



LCD MONITOR SET UP

This camera has a swiveling LCD monitor.

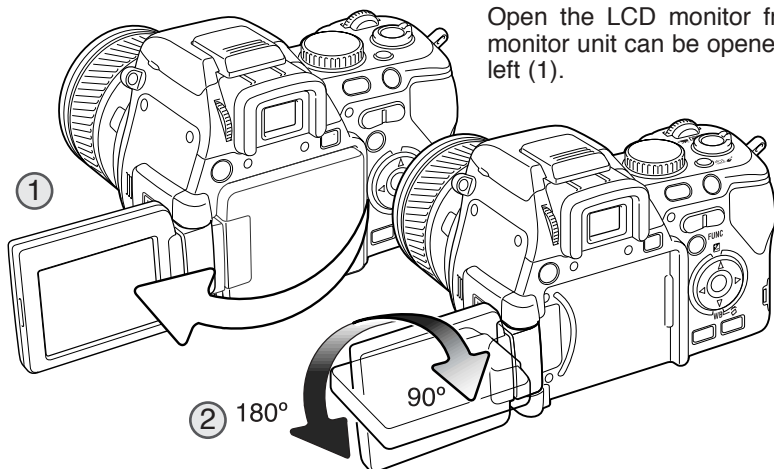

Open the LCD monitor from the right. The monitor unit can be opened up to 180° to the left (1).

When opened, the LCD monitor can be rotated 90° downward and 180° forward (2). Never force the monitor beyond this; the hinge will be damaged.

There is a clickstop every 90°.

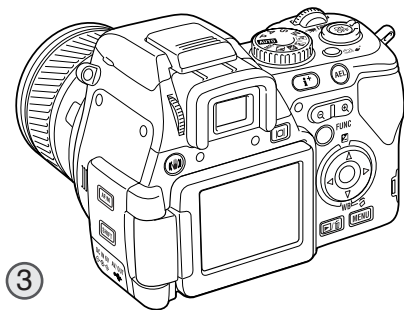

When the monitor is rotated 180° forward, the image is rotated automatically so that it is oriented correctly. If the monitor image appears up-side-down, check it has been rotated completely.

To set the monitor against the body, open the monitor unit to the left (1), rotate it 180° forward (2), and fold the monitor against the back of the camera (3).

When not in use, store the LCD monitor in its original position to protect the screen from damage.

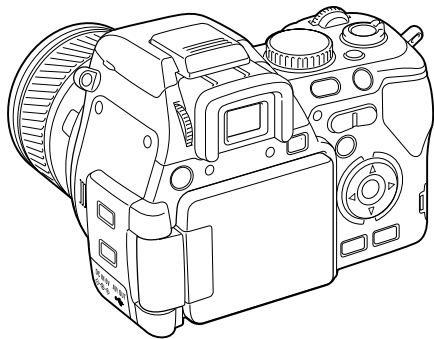

When the LCD monitor unit is closed with the screen facing the body, the EVF activates.

DISPLAY MODE BUTTON

Images can be viewed either with the EVF or LCD monitor.

Pressing the display mode button switches the active display between the EVF and monitor. Under bright light, the EVF allows easier viewing.

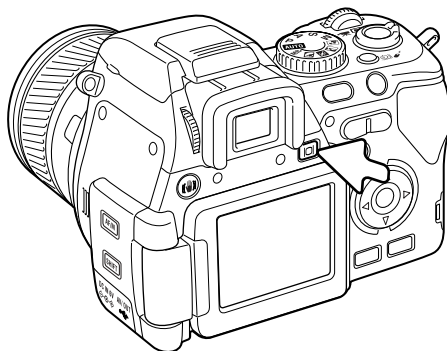

SETTING THE DATE AND TIME

After initially inserting a memory card and battery, the camera's clock and calendar must be set. When images are recorded, the image data is saved with the date and time of recording.

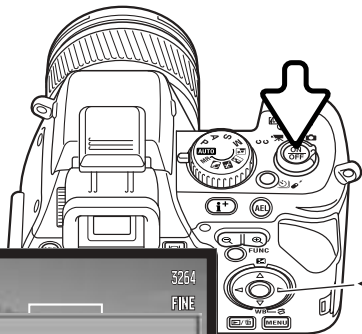

If the clock and calendar have not been set, a message is displayed each time the camera is turned on. This message is also displayed if the clock and calendar reset when the camera is stored without a battery for a long time.

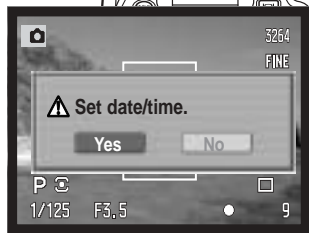

Use the left/right keys of the controller to select "Yes." "No" cancels the operation.

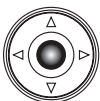

Press the center of the controller to open the date/time setup screen.



Date/Time setting screen



Use the left and right keys to select the item to be changed.



Use the up and down keys to adjust the item.



Press the central button to set the clock and calendar. The setup menu will be displayed.

SETTING THE MENU LANGUAGE

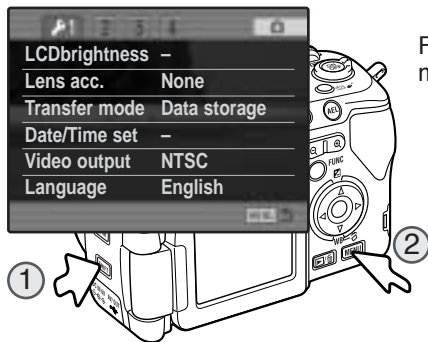

For customers in certain areas, the menu language must also be set.

While holding down the shift button (1) press the menu button (2) to open the setup menu.

Navigating the menu is simple. The up/down and left/right keys of the controller move the cursor and change settings on the menu. The center button of the controller selects menu options and sets adjustments.

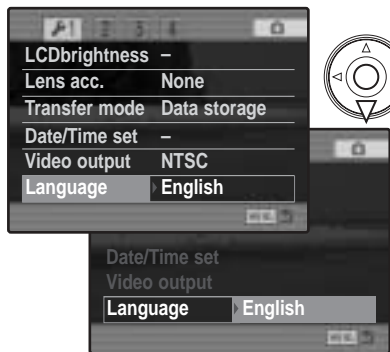

Use the down controller key to highlight the language menu option.



Press the right key to highlight the menu language.

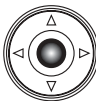

Press the central button of the controller to open the language screen.



Use the four-way key off the controller to highlight the new menu language.



Press the central button of the controller to set the language.

BASIC RECORDING

SETTING THE CAMERA TO RECORD IMAGES AUTOMATICALLY

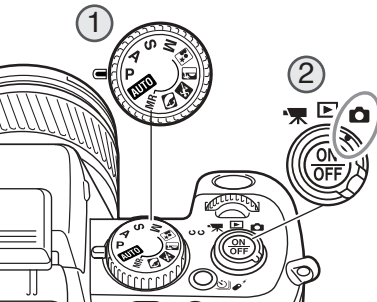

Set the exposure dial to the program (P) position (1). Confirm the mode switch is in the recording position (2).

All camera operations are now fully automatic. The autofocus, exposure, and imaging systems will work together to make photography effortless.

The Auto exposure mode acts like the program mode, except that the many of the recording functions are reset each time it is selected, see page 52 for more information.

BASIC RECORDING OPERATION

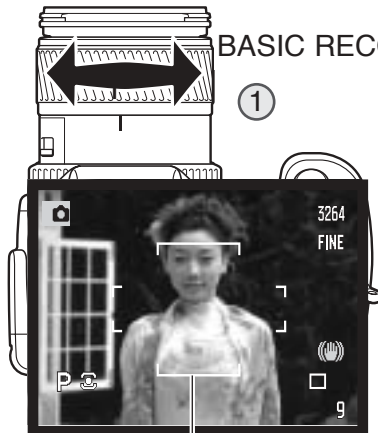

Use the zooming ring to frame the subject (1). The effect of the zoom is immediately displayed in the viewfinder (EVF) and LCD monitor.

Place the subject within the focus frame. For off-center subjects, use the focus-lock function (p. 32).

The subject must be within the focus range of the lens: 0.5m (1.6ft) - ∞ . For subjects closer than 0.5m (1.6ft), use the macro function (p. 49).

Focus frame

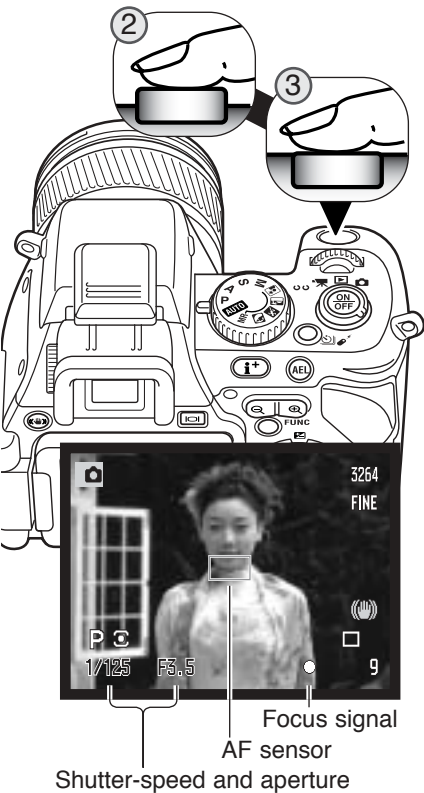

Press the shutter-release button partway down (2) to lock the focus and exposure.

When the focus is set, an AF sensor is displayed in the live image to indicate the point of focus. The focus signals (p. 33) on the monitors will confirm that the image is in focus. If the focus signal is red, the camera was unable to focus on the subject. Repeat the previous steps until the signal is white. The shutter speed and aperture value will change from white to black indicating the exposure is locked.

Press the shutter-release button all the way down (3) to take the picture. The access lamp blinks indicating the image data is being written to the memory card. Never remove a card while data is being transferred.

FOCUS LOCK

The focus-lock function is used when the subject is off-center and outside the focus frame. Focus lock may also be used when a special focusing situation prevents the camera from focusing on the subject.



Place the subject within the focus frame. Press and hold the shutter-release button partway down.

- The focus signals will indicate that the focus is locked. The shutter speed and aperture value will change from white to black indicating the exposure is locked.
- When the focus is set, an AF sensor is displayed on the live image to indicate the point of focus.



Without lifting your finger from the shutter-release button, recompose the subject within the image area. Press the shutter-release button all the way down to take the picture.

AUTOMATIC MONITOR AMPLIFICATION

In extremely low-light conditions when the camera-sensitivity gain has reached its limit, the automatic monitor-amplification function will intensify the EVF and LCD monitor image. The live image will be brighter. This will have no effect on the final image. This function can be turned off in section 3 of the recording menu (p. 101).

FOCUS SIGNALS

This digital camera has a quick, accurate autofocus system. The focus signals in the lower right corner of the EVF and LCD monitor indicate the focus status. For more information on autofocus modes, see p. 44.



White focus indicator - focus confirmed.



Red focus indicator - the subject is too close or a special situation is preventing the AF system from focusing. The shutter can be released.

If the AF system cannot focus on a certain subject, focus lock can be used with an object at the same distance as the main subject or the camera can be focused manually (p. 45).

SPECIAL FOCUSING SITUATIONS

The camera may not be able to focus in certain situations. If the autofocus system cannot focus on a subject, the focus icon will turn red. In this situation the focus-lock function can be used to focus on another object at the same distance as your main subject, and then the image can be recomposed to take the picture.



The subject is too dark.

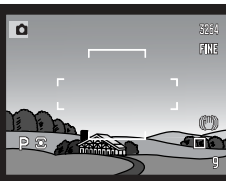

The subject in the focus frame is low in contrast.



Two subjects at different distances overlap in the focus frame.

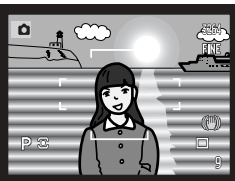

The subject is near a very bright object or area.

USING THE BUILT-IN FLASH

In low-light conditions or indoors, the flash is needed to illuminate the subject and reduce blurring through camera shake. The flash can also be used as a fill light in direct sunlight to soften harsh shadows. Always remove the lens hood when using the built-in flash; the hood may cast a shadow if mounted.

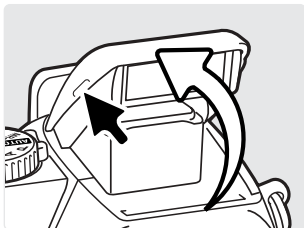

To use the flash, simply pull up the unit by the tabs on each side; confirm the flash is completely raised before using. The flash position must be set manually, and once up, the flash unit will always fire regardless of the amount of ambient light. The following indicators will appear in the upper left corner of the EVF and LCD monitors to show the flash status.



The red flash indicator appears when the flash is charging.



The white flash indicator appears when the flash is ready to fire.



After taking a picture, the OK indicator appears briefly if the flash properly exposed the subject.

FLASH RANGE - AUTOMATIC OPERATION

The camera will automatically control the flash output. For well-exposed images, the subject must be within the flash range. Because of the optical system, the flash range is not the same at the lens' wide-angle position as it is at the telephoto position.

Wide-angle position

0.5m ~ 3.8m (1.6 ft. ~ 12.5 ft.)

Telephoto position

0.5m ~ 3.0m (1.6 ft. ~ 9.8 ft.)



CAMERA-SHAKE WARNING

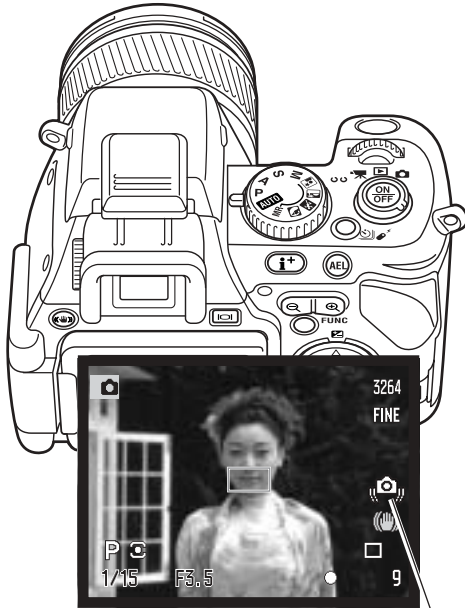

If the shutter speed falls below the point where the camera can be safely hand held, the camera-shake warning appears on the monitors regardless if Anti-shake is active.

Camera shake is slight blurring caused by subtle hand motion and is more pronounced at the telephoto position of the lens than at the wide-angle. Although the warning appears, the shutter can still be released.

If the warning appears when the shutter-release button is pressed partway down, place the camera on a tripod, use the flash, Anti-shake, increase the camera sensitivity (ISO) (p. 66), or zoom the lens towards the wide-angle position until the warning disappears.

Camera-shake indicator

((🖐️)) ANTI-SHAKE SYSTEM

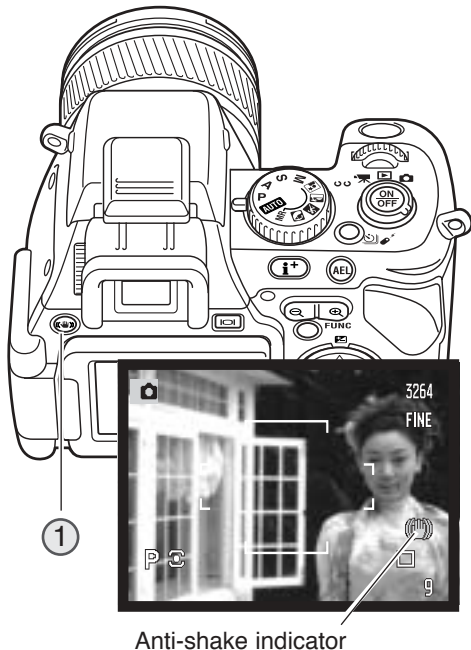

Anti-shake indicator

The Anti-shake system minimizes the affect of camera shake. Anti-shake is employed when the shutter speed falls below a certain limit depending on the focal length in use. The effectiveness of Anti-shake depends on the shutter speed in use and the degree of shaking. The system may not work with moving subjects or when the camera is panned.

When the system is active, the Anti-shake indicator appears. Anti-shake can be turned off and on by pressing the Anti-shake button (1).

Frame the subject as described in the basic operation section and press the shutter-release button partway down. Confirm the image has stabilized on the monitor and press the shutter-release button all the way down to take the picture.

Anti-shake is not effective with a tripod mounted camera; turn off the Anti-shake function to conserve power.

If the camera is overheating because of operating and ambient temperatures, the Anti-shake indicator turns red and the system will turn off automatically. Allow the camera to cool before using Anti-shake.

BASIC PLAYBACK

Images can be viewed in the Quick View or playback modes. This section covers the basic functions in both modes. The playback mode has additional menu functions, see page 112.

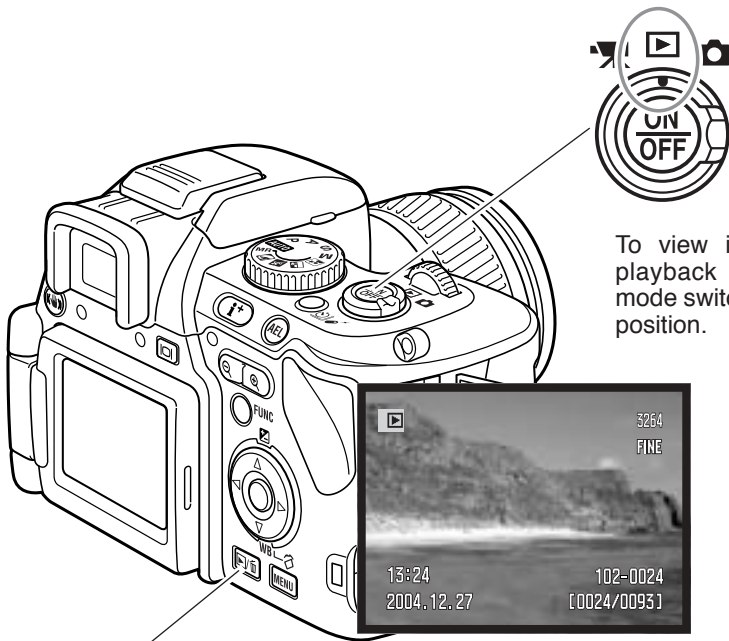

To view images from the playback mode, turn the mode switch to the playback position.



To view images from the recording or movie recording modes, press the Quick View / delete button.

SINGLE-FRAME PLAYBACK AND HISTOGRAM DISPLAY

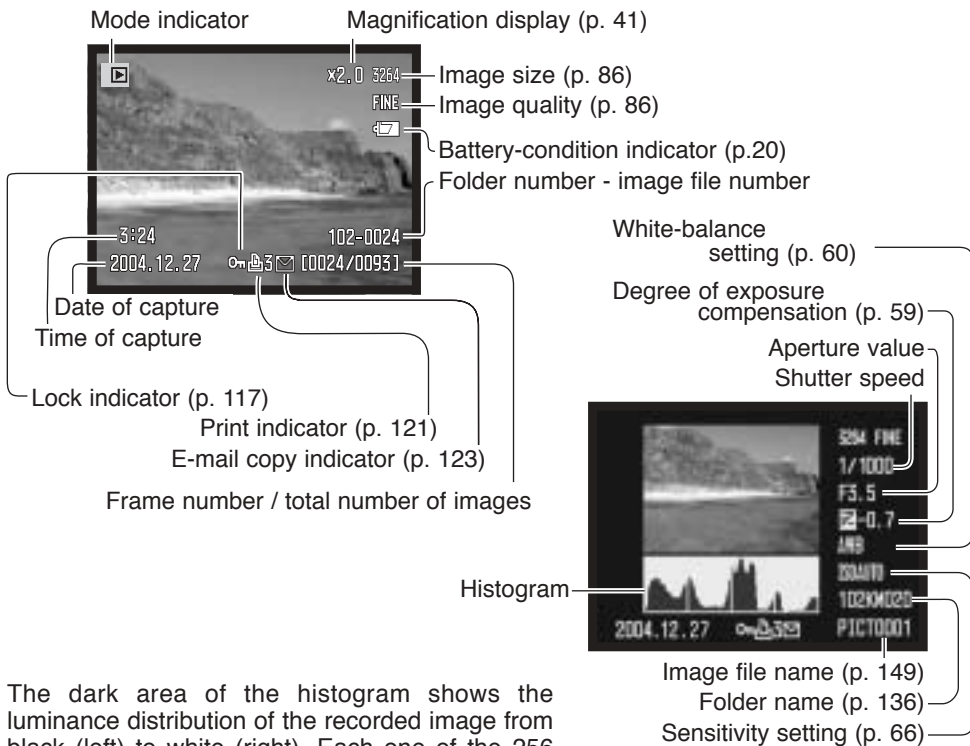

The dark area of the histogram shows the luminance distribution of the recorded image from black (left) to white (right). Each one of the 256 vertical lines indicates the relative proportion of that light value in the image. The histogram can be used to evaluate exposure and contrast, but displays no color information. Areas of the image approaching the shadow and highlight luminance limit blink in the image thumbnail.

VIEWING IMAGES AND HISTOGRAM

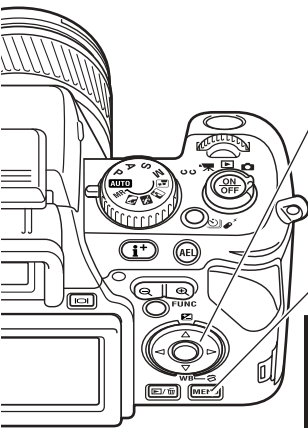

When in the Quick View or playback mode, use the left/right keys of the controller to scroll through the images on the memory card.



To view the histogram of a still image, press the up key. Press the down key to return to single-frame playback.



To return to a recording mode from Quick View, press the menu button.



ROTATING IMAGES

Press the down key of the controller to rotate a displayed image 90° left, 90° right, or horizontally.



DELETING SINGLE IMAGES

The displayed image can be deleted. Once deleted, an image cannot be recovered.



To delete a displayed image, press the Quick View/delete button; a confirmation screen will appear.



Use the left/right keys to highlight "Yes." "No" will cancel the operation.



Press the controller to execute the command on the confirmation screen. The camera will return to playback mode.



Confirmation screen

CHANGING THE QUICK VIEW & PLAYBACK DISPLAY

The display information button controls the display format. Each time the button is pressed, the display changes between full display and image only.

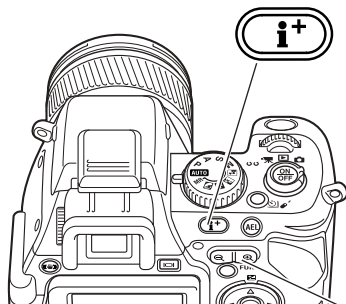

Full display

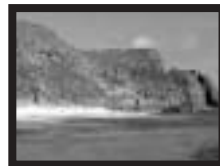

Image only

INDEX PLAYBACK



To view the recorded images in a 9-frame index, press the left side of the digital-zoom lever.



Index playback

In index playback, the four-way keys of the controller moves the yellow border to the adjacent image. When the image is highlighted with the border, the date of recording, E-mail copy indicator, the lock and printing status, and the frame number of the image are displayed at the bottom of the screen. The highlighted image can be deleted using the QuickView/delete button (p. 39). When either side of the digital-zoom lever is pressed, the highlighted image will be displayed in the single-frame playback mode.

The control dial displays the next 9 frames.

ENLARGED PLAYBACK

In single-frame playback, a still image can be enlarged up to 10X for closer examination. The starting magnification can be selected from 2X, 4X, and 10X in section 2 of the playback menu (p. 120). RAW images cannot be enlarged.

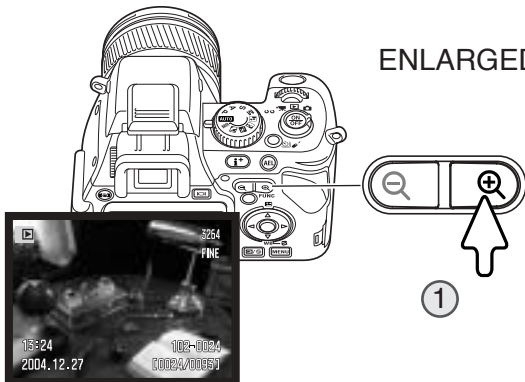

Press the right (+) side of the digital-zoom lever (1) to enlarge the image. The degree of magnification is displayed on the monitors. To reduce the magnification, press the left (-) side of the lever; magnification can be reduced to 1.1X. Holding down the shift button on the left side of the body and pressing the digital-zoom lever changes the magnification in larger increments.

Control dial can be used to scroll through the image files. If the subsequent image has same orientation and size, it will be displayed with the same magnification.



Scroll arrow

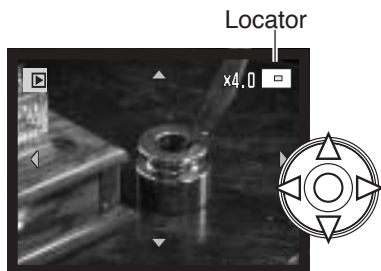

Use the four-way key to scroll the image. Holding down the shift button on the left side of the body and pressing the four-way key scrolls the image faster. The locator shows the area of the image being viewed.

Pressing the menu button or reducing the magnification below X1.1 cancels the enlarged playback. Press the display information button (i+) to hide or show the display indicators.

ADVANCED RECORDING

This section contains detailed information on the camera's recording functions and operation. Read the sections pertaining to your interest and need.

RECORDING MODE DISPLAY

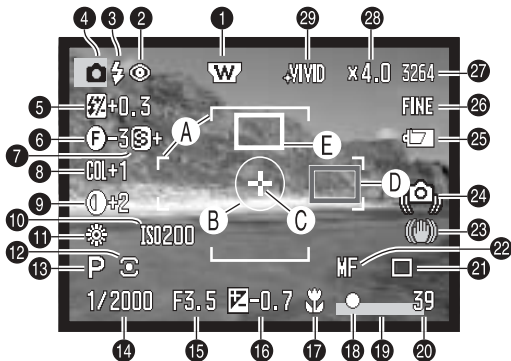

1. Lens-accessory indicator (p. 132)
2. Flash-mode indicator (p. 70)
3. Flash signal (p. 34)
4. Mode indicator
5. Flash-compensation display (p. 59)
6. Filter display (p. 73)
7. Sharpness display (p. 94)
8. Color-saturation-compensation display (p. 74)
9. Contrast-compensation display (p. 74)

- A. Focus frame
B. Spot metering area (p. 72)
C. Flex Focus Point (p. 48)

10. Camera-sensitivity (ISO) display (p. 66)
11. White-balance indicator (p. 60)
12. Metering-mode indicator (p. 72)
13. Exposure-mode indicator (p. 50)
14. Shutter-speed display
15. Aperture display
16. Exposure-compensation display (p. 59)
17. Macro-mode indicator (p. 49)
18. Focus signal (p. 33)
19. Date-imprinting indicator (p. 95)
20. Frame counter (p. 87)
21. Drive-mode indicator (p. 76)
22. Focus-mode indicator (p. 44)
23. Anti-shake indicator (p. 36)
24. Camera-shake indicator (p. 35)
25. Battery-condition indicator (p. 20)
26. Image-quality indicator (p. 86)
27. Image-size display (p. 86)
28. Magnification display (p. 102)
29. Color-mode indicator (p. 68)

- D. AF sensor (red) (p. 31)
E. Spot AF area (white) (p. 47)

DISPLAY INFORMATION BUTTON

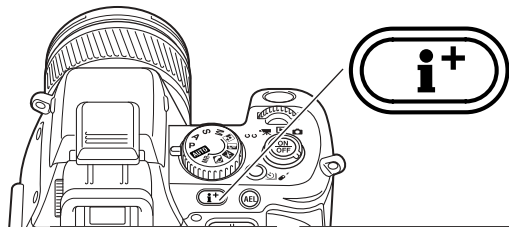

The display information button controls what information is displayed with the live image. Each time the button is pressed, the display cycles to the next format: standard display, real-time histogram, focus frame only, and live image only.



Standard display



Real-time histogram



Focus frame only

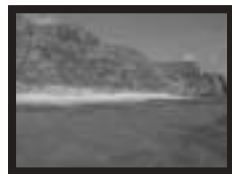

Live image only

The real-time histogram shows the approximate luminance distribution of the live image. This histogram will not be accurate when the monitor image is amplified (p. 32, 101), or the built-in or a compatible flash unit (p. 91) is used. The histogram of a recorded image may not show the same distribution as the real-time histogram.

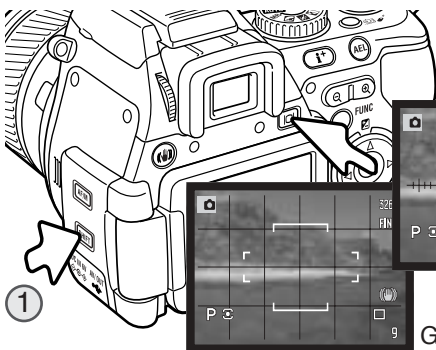

Scale

To display a grid or scale over the display formats, press and hold the shift button (1) and press the display information button to cycle through the options: grid, scale, and off.

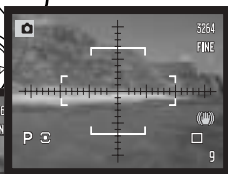

Grid

FOCUS-MODE BUTTON

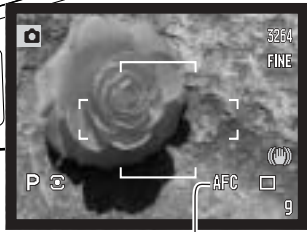

Single-shot AF (Autofocus), continuous AF, and manual focus is set with the focus-mode button. Press the button to select the appropriate focus mode.

The continuous AF and manual focus-mode indicators will be displayed in the lower right corner of the monitors.

Single-shot AF - a general purpose autofocusing mode. Its operation is described in the basic recording section.

AFC

Continuous AF - used for photographing moving subjects. When the shutter-release button is pressed partway down, the autofocus system will activate and continue to focus until the exposure is made. When using continuous AF with the wide focus area (p. 46), the AF sensors used to indicate the point of focus will not be displayed.

The continuous AF mode may have difficulty focusing on fast subjects. In this situation, use manual focus to focus on a point in the subject's path and release the shutter-release button just before the subject reaches that point; there is a slight delay between the time the shutter-release button is pressed and the shutter opens.

MF

Manual focus - To manually focus the camera. See the following section for operation.

Focus signals

- Single-shot AF** - focus confirmed and locked.
- Continuous AF** - focus confirmed.
- Red focus indicator** - the subject is too close or a special situation is preventing the AF system from focusing. The shutter can be released.

MANUAL FOCUS AND FLEX DIGITAL MAGNIFIER

The manual focus mode can be set with the focus-mode button (p. 44). Always use the monitor image to confirm focus. The approximate object distance from the CCD is displayed near the frame counter.

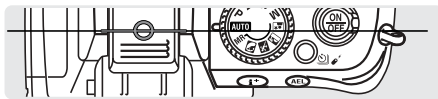

Approximate location of the CCD plane

The Flex Digital Magnifier is a focusing aid for manual focus. The live image within the magnification area is automatically magnified to judge sharpness as the focusing ring is turned. The Flex Digital Magnifier is disabled when using the digital zoom.

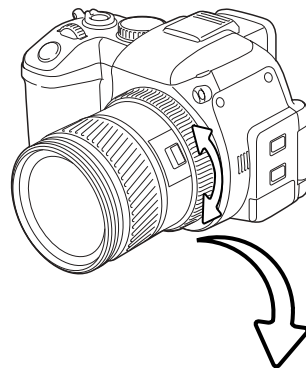

Turn the focusing ring to focus the camera. The image within the magnification area is enlarged. The locator shows which portion of the image is displayed. When the shutter-release button is pressed partway down, or the camera is not focused for several seconds, the entire image area is displayed.

During manual focus, the magnification area or magnified image can be moved. Press the central button of the controller, then use the four-way keys to move the area; the magnification area will turn blue. The magnified image area can be scrolled using the four-way keys.

Holding down the shift button on the side of the body and pressing the central button of the controller centers the area.



Object distance

Locator

CHANGING AF-AREA MODES

AF-area modes can be selected between the wide focus frame, spot AF area, and Flex Focus Point. The AF-area modes cannot be changed when using the digital zoom.

Press the center button of the controller; the active focus frame turns blue.

Turn the control dial to cycle through the AF-area modes.

Wide focus area - a general purpose focus area. Its operation is described in the basic recording section (p. 30).

Spot AF areas - eleven selectable focus areas (p. 47).

Flex Focus Point - a cross-hair focus point that can be placed anywhere in the image area (p. 48).

Use the four-way keys of the controller to select the spot AF area or move the Flex Focus Point. Press the center of the controller or press the shutter-release button partway down to set the AF-area; the selected AF area turns white. See instructions in the following pages.

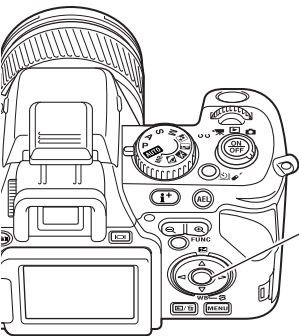

SPOT AF AREAS

One of the eleven spot AF areas can be selected. Spot AF areas cannot be used with the digital zoom or movie recording.



Press the central button of the controller and select the spot AF area mode using the control dial as described on the previous page.

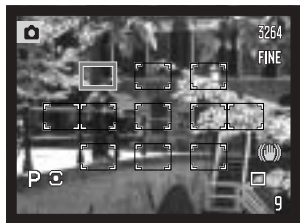

When the spot AF area mode is selected, eleven spot AF areas are displayed. The active AF area is blue. Use the controller's four-way keys (1) to select a new area.

SHIFT



Pressing the center button of the controller while pressing the shift button resets the AF area to the center.



Press the center button of the controller to select the area; the other ten areas disappear. Only when a focus area has been selected, can the controller be used for other camera operations.



Pressing the shutter-release button partway down also completes the operation; the spot AF area turns red briefly to confirm focus.

Once a focus area is selected, it remains active even after the picture has been taken. Press the center of the controller to select another area.

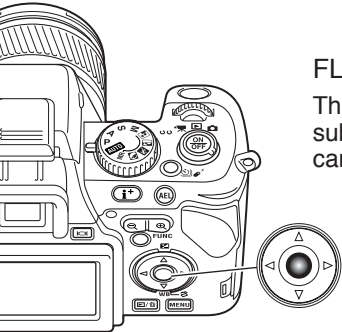

FLEX FOCUS POINT

The Flex Focus Point (FFP) is a powerful tool for off-center subjects. It can be moved to any point in the image area. The FFP cannot be used with the digital zoom or movie recording.

Press the central button of the controller and select the FFP mode using the control dial as described on page 46.



When the FFP mode is selected, a blue crosshair is displayed. Use the controller's four-way keys to move the Flex Focus Point in the live image. Pressing the shift button while using the four-way key moves the point faster.

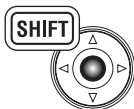

Pressing the central button of the controller while pressing the shift button returns the focus point to the center of the image area.



Press the central button of the controller to fix the position; the Flex Focus Point turns white.

Pressing the shutter-release button partway down also completes the operation; the FFP turns red briefly to confirm focus.



Press the center of the controller to move the Flex Focus Point to another location.

MACRO MODE

The macro mode is used for close-up photographs of small objects. The built-in flash cannot be used with macro mode. The use of a tripod is recommended.

Align one of the arrows on the zooming ring with the index next to the macro switch and slide the switch forward. The lens must be zoomed to the wide-angle or telephoto position for the macro switch to engage. The zooming ring is locked at the wide-angle position. At the telephoto position, the zooming ring can move slightly to make fine adjustments to image size.

The macro indicator is displayed in the lower right corner of the monitors. Make sure the subject is within the macro focusing range:

Wide-angle position	0.3 ~ 0.6m (12 ~ 24 in.)
---------------------	--------------------------

Telephoto position	0.25 ~ 0.6m (10 ~ 24 in.)
--------------------	---------------------------

Approximate location of the CCD plane

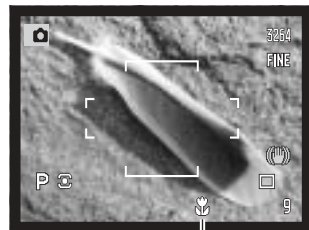
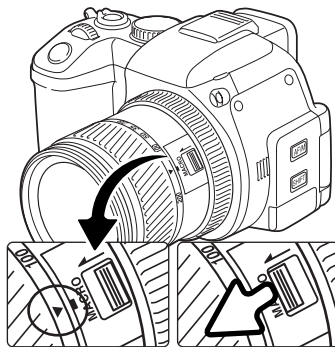
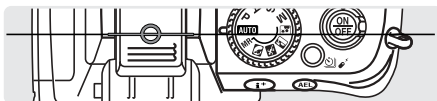

Macro-mode indicator

Shooting tips

Because of the high image magnification, hand holding cameras during close-up photography is very difficult. When possible, use a tripod.

Use the Flex Focus Point to specify the area to be in focus. Because depth of field (the area in focus) is narrow in close-up photography, using focus lock with off-center subjects can cause minor errors which are exaggerated at high magnifications.

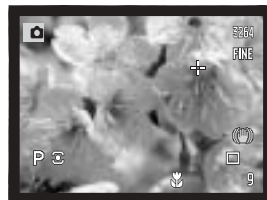

EXPOSURE LOCK

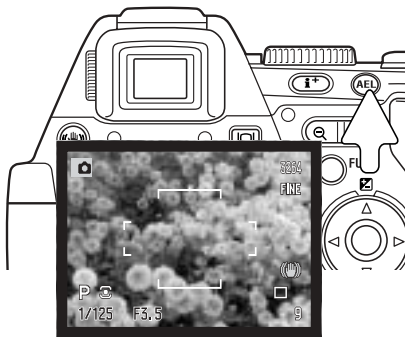





The AE lock button locks the automatic exposure system. This function allows the exposure to be set by a gray card or reference target outside the scene. When using flash in the P or A exposure modes, slow-shutter sync is active (p. 71). The operation of the AE lock button can be customized in section 1 of the recording menu (p. 92).

Press and hold the AE lock button to lock the exposure; the shutter speed and aperture monitor displays turns black; releasing the button cancels the setting. Frame the subject and press the shutter-release button partway down to lock focus.

EXPOSURE-MODE DIAL

The exposure-mode dial is used to select traditional exposure modes as well as subject programs that optimize camera settings to specific shooting conditions. Camera settings saved in the camera can also be recalled with this dial. Simply turn the dial to the appropriate position.

- M** Manual exposure (p. 56)
- S** Shutter priority (p. 55)
- A** Aperture priority (p. 54)
- P** Program exposure (p. 51)
- AUTO** Auto recording (p. 52)
- MR** Memory recall (p. 99)
-  Portrait subject program (p. 58)
-  Sports action subject program (p. 58)
-  Sunset subject program (p. 58)
-  Night portrait subject program (p. 58)



Exposure-mode indicator

PROGRAM - P

Program exposure is set with the exposure-mode dial (p. 50). The program AE uses luminance and focal-length information to calculate exposures. This allows the photographer to shoot without worrying about exposure settings. The shutter speed and aperture values of the exposure are displayed on the monitors. If the brightness level of the scene is outside the exposure control range of the camera, the shutter-speed and aperture displays turn red on the monitors.

PROGRAM SHIFT - Ps/PA

Program-shift function allows adjustment to the shutter-speed/aperture combination determined by the camera. The built-in flash cannot be used with program shift. The camera gives priority to the flash exposure; once the flash is raised, any changes made with program shift are canceled.

As described in the basic recording operation (p. 30), press the shutter-release button partway down until the shutter speed and aperture value are displayed.

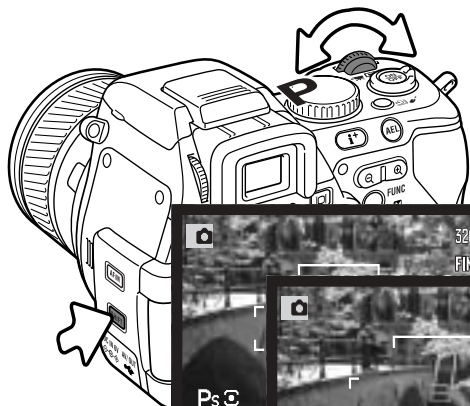

Turn the control dial to change the shutter speed (Ps).

Turn the dial while pressing the shift button to change the aperture (PA).



Each shutter speed and aperture combination gives the equivalent exposure. The values are shifted in 0.3Ev or 1/3 stop increments. If the lighting changes, the shifted value remains fixed and the other display changes to compensate for the required exposure.

AUTO RECORDING

Auto recording is set with the exposure-mode dial. Auto recording is the same as the program exposure mode (p. 51), except that when the camera is on, if the exposure mode dial is turned to or from the auto position, the auto exposure mode is reset. Turning the camera off will not reset the mode. The following functions are reset:

Anti-shake	On	p. 36
Focusing screen	Off	p. 43
Display format	Standard	p. 43
Focus mode	Single-shot AF	p. 44
Focus-area mode	Wide focus frames	p. 46
Exposure compensation	0.0	p. 59
Flash compensation	0.0	p. 59
White balance	Auto	p. 60
Camera sensitivity (ISO)	Auto	p. 66
Color mode	Natural (sRGB)	p. 68
Flash mode	Fill flash	p. 70
Metering mode	Multi-segment	p. 72
Filter	0	p. 73
Color-saturation compensation	0	p. 74
Contrast compensation	0	p. 74
Drive mode	Single-frame advance	p. 76
Image size	3264 x 2448	p. 86
Image quality	Fine	p. 86
Spot AE area	Center spot	p. 90
Flash control	Auto	p. 90
Flash output (Manual)	1/4	p. 90
AEL button	AE hold	p. 92
Sharpness	Normal	p. 94

Date imprinting	Off	p. 95
Instant playback	Off	p. 96
Full-time AF	Off	p. 97
Direct Manual Focus (DMF)	Off	p. 97
Noise reduction	On	p. 100
Monitor amplification	Auto	p. 101
Monitor amplification - Manual exp.	Exposure priority	p. 101
Digital zoom	Interpolate	p. 102

Konica Minolta History



Innovation and creativity has always been a driving force behind our products. The Electro-zoom X was purely an exercise in camera design. It was unveiled at Photokina in Germany in 1966.

The Electro-zoom X was an electronically controlled aperture-priority mechanical SLR with a built-in 30 - 120mm f/3.5 zoom lens giving twenty 12 X 17mm images on a roll of 16mm film. The shutter-release button and battery chamber are located in the grip. Only a few prototypes were built making it one of our rarest cameras.

APERTURE PRIORITY - A

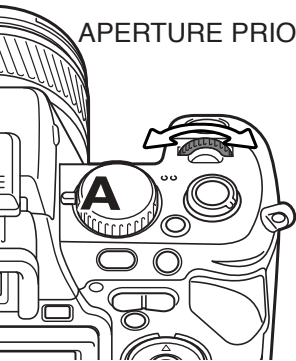

Aperture priority is set with the exposure-mode dial (p. 50). The photographer selects the aperture and the camera sets the appropriate shutter speed to ensure the correct exposure. When A mode is selected, the aperture display on the monitors turns blue.

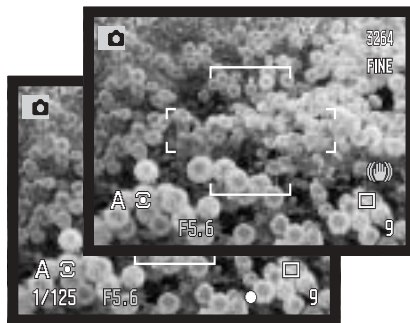

Turn the control dial to change the aperture. Press the shutter-release button partway down to activate the exposure system; the corresponding shutter speed is displayed.

The aperture values can be changed by 0.3Ev or 1/3 stop increments between f/2.8 and f/11 at the lens' wide-angle position and f/3.5 to f/11 at the lens' telephoto position. If the aperture value is beyond the shutter-speed range, the shutter-speed display turns red on the monitors.

With the camera sensitivity (ISO) set to auto (p. 66), the shutter speed may not change when the aperture is adjusted because the shutter speeds can be adjusted in fine steps.

Camera Notes

When photographing scenes with very bright objects such as the sun at large apertures (f/2.8 or f/3.5), streaking may be apparent in the image. Black areas caused by a loss of data may result. In these situations, stop down the aperture or use neutral density filters to minimize the effect.

Do not point the camera toward the sun for prolonged periods of time. The intensity of the sun could damage the CCD. Between exposures, turn off the camera or cover the lens.

SHUTTER PRIORITY - S

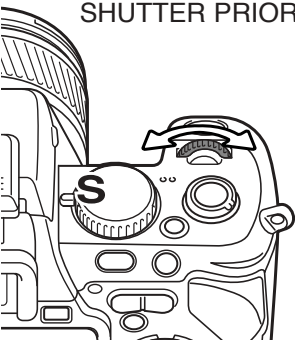

Shutter priority is set with the exposure-mode dial (p. 50). The photographer selects the shutter speed and the camera sets the appropriate aperture to ensure correct exposure. When S mode is selected, the shutter speed display on the monitors turns blue.

Turn the control dial to change the shutter speed. Press the shutter-release button partway to activate the exposure system; the corresponding aperture will be displayed.

The shutter speeds can be changed by 1/3 stop increments from 1/1600 second, see below. If the shutter speed is beyond the aperture range, the aperture display turns red on the monitors.

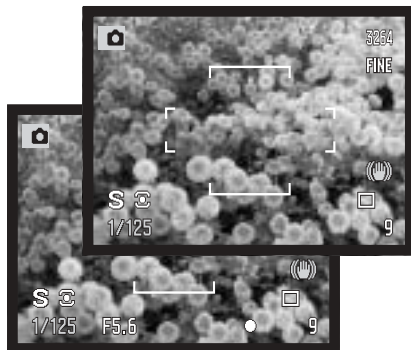

When using flash, the shutter speed should be set to the flash duration of flash unit to prevent underexposure. A maximum shutter speed of 1/1000s is recommended when using the built-in flash and 1/250s when using a compatible Minolta flash unit.

The camera-shake warning does not appear in S mode.

SHUTTER-SPEED RANGE AND CAMERA SENSITIVITY (ISO)

The maximum shutter speed or bulb exposure depends on the camera sensitivity (ISO) setting.

ISO is changed with the function button. For more about camera sensitivity, see page 66.

ISO setting	Shutter speed
50	30 seconds
100	30 seconds
200 / AUTO	15 seconds
400	8 seconds
800	4 seconds

MANUAL EXPOSURE - M

Manual exposure mode allows individual selection of shutter speeds and apertures. This mode overrides the exposure system giving the photographer total control over the final exposure. Manual exposure is set with the exposure-mode dial (p. 50).

The shutter speeds and aperture values can be changed in 1/3 stop increments. The shutter speed range in manual exposure mode is 30 to 1/1600 second including bulb (p. 57). With auto ISO, the camera sensitivity is set to ISO 100. The maximum shutter speed changes with sensitivity, see page 55.

As changes are made to the exposure, the effect will be visible on the monitors. The shutter-speed and aperture display turns red on the monitors if the image is extremely under or overexposed. If the monitors are black, increase the exposure until the image is visible; decrease the exposure if the monitors are white. The recording menu can be used to constantly display a live image regardless of the exposure setting (p. 101)

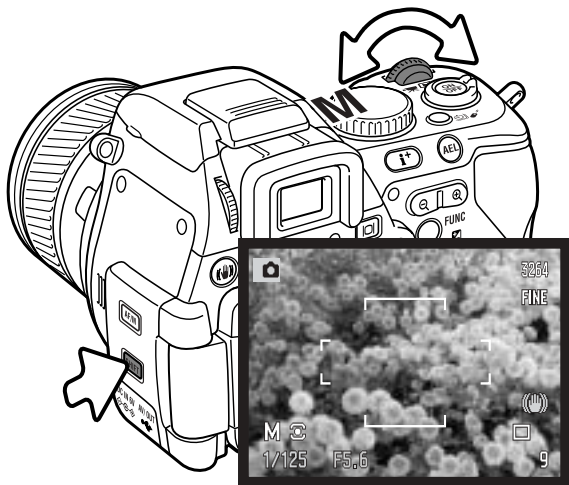

To set the shutter speed, turn the control dial. To set the aperture, press and hold the shift button and turn the control dial; the left/right keys of the controller can also be used to change the aperture when shooting vertical pictures.

To use manual shift, press and hold the AE lock button while turning the control dial; both the shutter speed and aperture are changed without affecting the total exposure.

When using flash, the shutter speed should be set to the flash duration of flash unit to prevent underexposure. A maximum shutter speed of 1/1000s is recommended when using the built-in flash and 1/250s when using a compatible Minolta flash unit.

The camera-shake warning does not appear in M mode.

BULB EXPOSURES

Bulb photographs can be taken in the manual-exposure mode (M). The maximum exposure time depends on the camera sensitivity setting, see page 55. The use of a tripod and a Wireless Remote Control RC-D1 is recommended for bulb exposures. The camera's exposure system cannot be used to calculate bulb exposures. The use of a separate light meter is recommended.

Use the control dial to decrease the shutter speed until "bulb" is displayed.

Press and hold the shift button and turn the control dial to set the appropriate aperture required for the exposure.

To take the picture, press and hold the shutter-release button for the duration of the exposure. Releasing the shutter button will end the exposure.

The monitors will be blank during the exposure. The shutter sound effect will signal the end of the exposure. The monitors will remain blank for up to 30 seconds while noise-reduction processing is applied to the image.

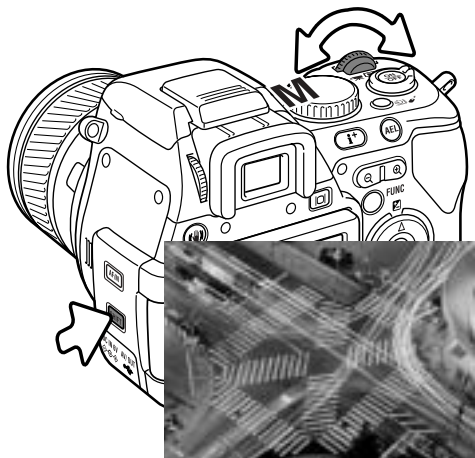

DIGITAL-SUBJECT-PROGRAMS

Digital subject programs optimize the camera's exposure, white-balance, and image-processing systems for specific conditions and subjects. Simply turn the exposure mode dial to select the appropriate subject program.

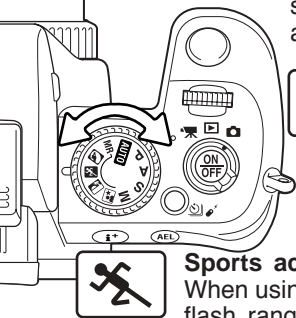

Portrait - optimized to reproduce warm, soft skin tones and a slight defocusing of the background. Most portraits look best at a telephoto setting; the longer focal length does not exaggerate facial features and the shallower depth of field softens the background. Use the built-in flash with strong direct sunlight or backlight to reduce harsh shadows.



Sports action - used to capture fast action by maximizing shutter speeds. When using a flash, make sure the subject is within the flash range (p. 67). The flash range can be extended by changing the camera sensitivity (p. 66). A monopod is more flexible and compact than a tripod when shooting events.



Sunset - optimized to reproduce rich, warm sunsets. When the sun is above the horizon, do not point the camera toward the sun for prolonged periods of time. The intensity of the sun could damage the CCD. Between exposures, turn off the camera or cover the lens.



Night portrait - for deep, subtle night scenes. When used with flash, the subject and background exposures are balanced. Use a tripod to eliminate blurring from camera shake. The flash can only be used with close subjects such as with a portrait of a person. When using the flash, ask your subjects not to move after the burst; the shutter will still be open for the background exposure.

Not all recording functions can be used when using Digital Subject Programs.

EXPOSURE AND FLASH COMPENSATION

The ambient light and flash exposure can be adjusted before the image is captured to make the final picture lighter or darker. Exposure can be adjusted by as much as $\pm 2\text{Ev}$ in $1/3$ increments (p. 105). The exposure and flash compensation will remain in effect until it has been reset. For more on exposure and flash compensation, see page 59.

Adjustments to exposure must be set before the image is captured. When setting exposure or flash compensation, the change in Ev is shown on the monitors. After the setting is made, the shutter-speed and aperture displays will indicate the actual exposure.

Press the up key of the controller (1) to display the exposure and flash compensation screen.

Use up/down keys of the controller (2) to select exposure or flash compensation. Use the left/right keys (3) to adjust the degree of compensation.

Press the central button of the controller or press shutter-release button partway down to complete the operation. The values will automatically be set if a change is not made for a few seconds. If any other value except 0.0 was set, an indicator is displayed on the monitor as a warning. Also see the camera notes on page 69 and 75.

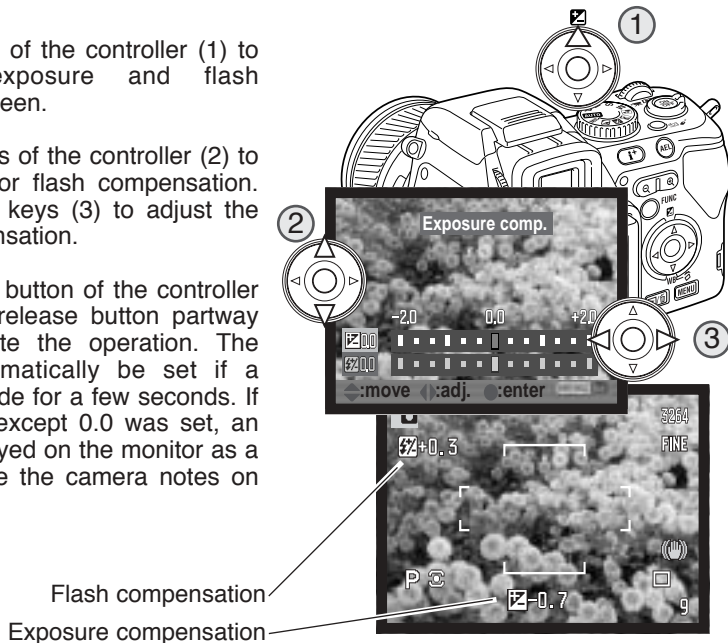

WHITE BALANCE

White balance is the camera's ability to make different types of lighting appear natural. Any changes are immediately visible on the monitors.

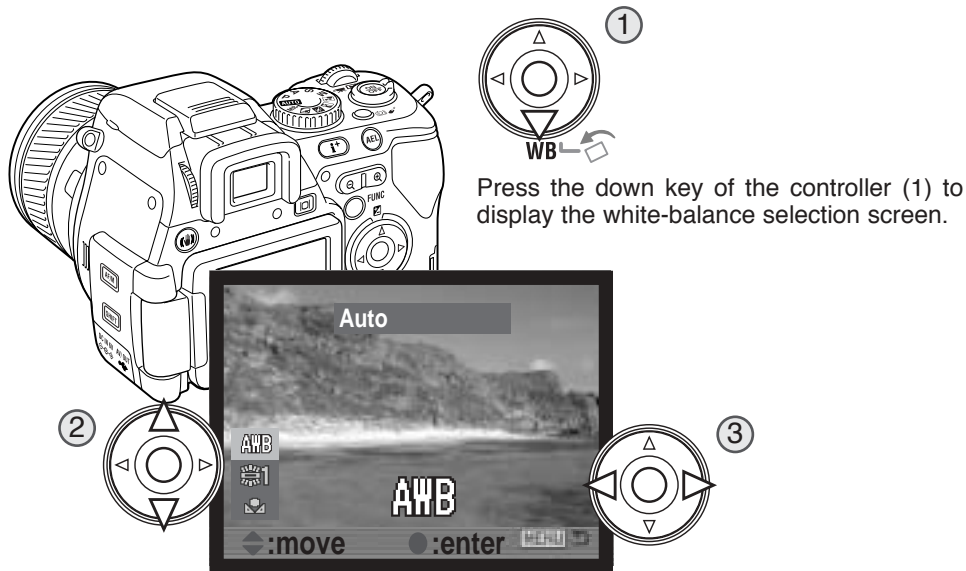

Press the down key of the controller (1) to display the white-balance selection screen.

Use the up/down keys of the controller (2) to select between auto, preset, or custom white balance. The left/right keys (3) change the preset and custom white balance settings. Press the shutter-release button partway down or press the central button of the controller to complete the operation. Also see the camera notes on page 69.



When preset or custom white balance is set, an indicator appears on the monitors.

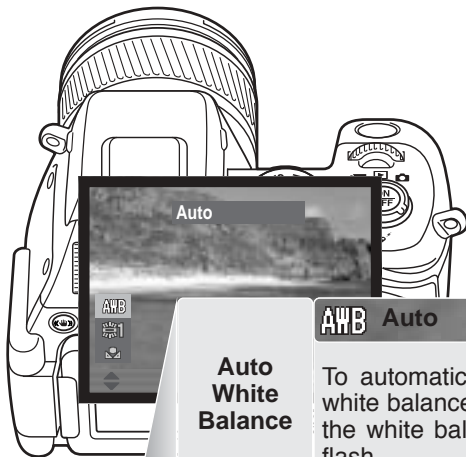







Auto White Balance

AWB Auto

To automatically detect the type of light and adjust the white balance accordingly. When the built-in flash is used, the white balance is set for the color temperature of the flash.

Preset white balance

-  Daylight
-  Shade
-  Cloudy
-  Tungsten
-   Fluorescent 1, 2
-  Flash

To set the white balance to a specific light source. Fluorescent 1 is for standard fluorescent lighting, and fluorescent 2 is for daylight fluorescent lighting. For information on light sources, see page 105.

Custom white balance

-  Set Custom set
-   Custom recall 1, 2

To apply or calibrate custom white-balance. Up to two custom white balance settings can be registered and recalled. See the next page for further instructions.

CUSTOM WHITE-BALANCE CALIBRATION

Custom-white-balance function allows the camera to be calibrated to a specific lighting condition. Two settings can be stored in the camera and used repeatedly. Custom white balance is especially useful with mixed-lighting conditions or when critical control over color is needed.

Select the custom set option on the white-balance selection screen, see previous page.

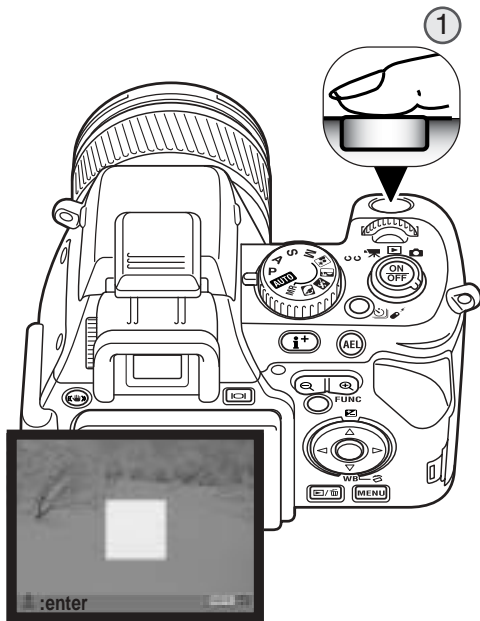

The measuring area is displayed on the calibration screen. Select a white object and fill the measuring area with it.

Press the shutter-release button all the way down (1) to calibrate the camera.

On the register-selection screen use the left/right keys of the controller (2) to select the custom white-balance register in which to store the setting; any previous setting is replaced. Press the central button of the controller (3) to complete the operation. The menu button cancels the operation without saving the setting.

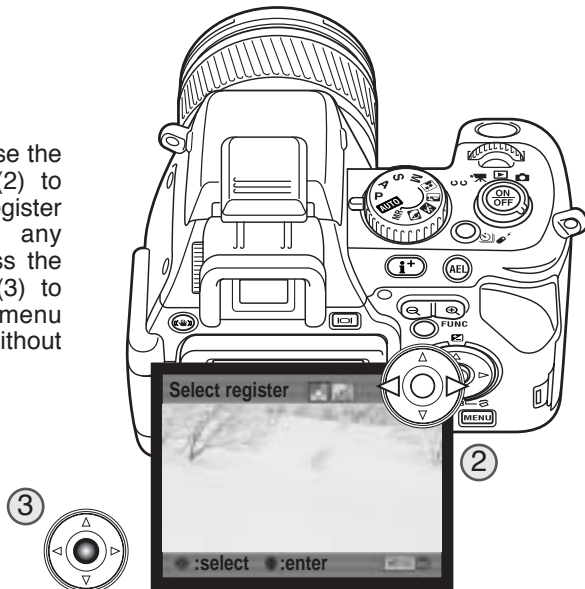

If an error occurs during calibration, a message appears on the monitors. Press the controller to cancel the message and press the menu button to cancel the register-selection screen; the custom white-balance indicator will be yellow to indicate the error. Recalibrate using a suitable reference target. A calibration error may occur under extremely bright light sources, especially with flash units. Use a gray card as the calibration target to reduce the intensity of the illumination.

Shooting tips

When making the calibration, the color of the object used is critical. The object should be white. A colored object will cause the calibration to compensate for the object color rather than the color temperature of the ambient light. A blank piece of white paper is an ideal surface and can easily be carried in a camera bag.

USING THE FUNCTION BUTTON

The camera sensitivity, color mode, flash mode, metering mode, filter, color saturation, and contrast settings are controlled by the function button. Only filter, color saturation, and contrast can be set in the movie recording mode.

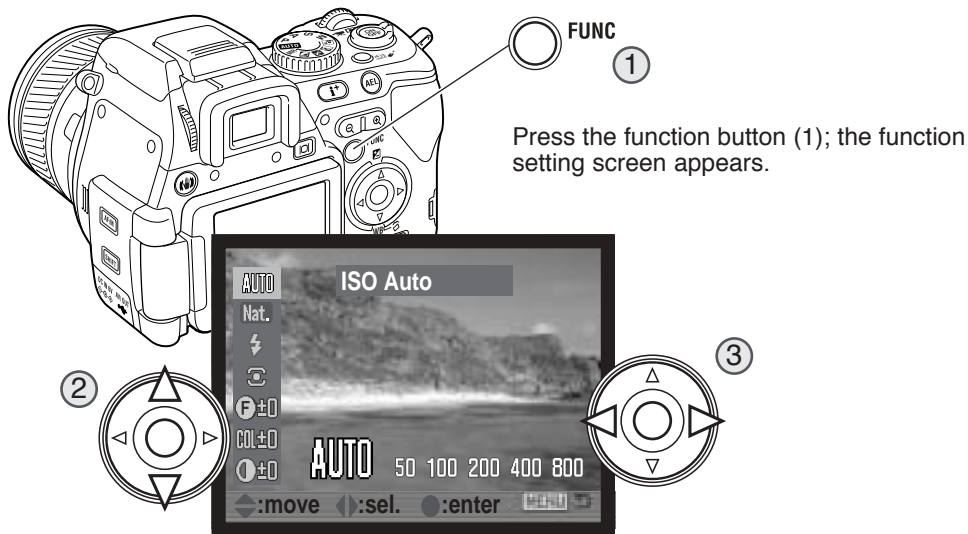

Press the function button (1); the function setting screen appears.

Use the up/down keys of the controller to highlight the function (2), and the left/right keys to change the setting (3). Press the center of the controller or the shutter-release button partway down to complete the operation.

Pressing the menu button cancels the operation. Also see the camera notes on page 69 and 75.

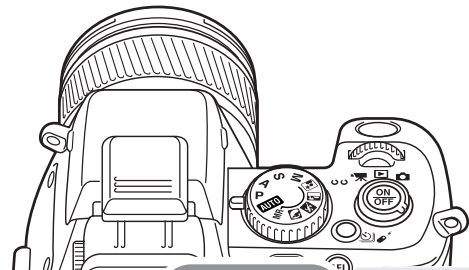

ISO	Changes camera sensitivity (p. 66).
Color mode	To select color or B&W images, color space, or portrait (p. 68).
Flash mode	To set the flash mode of the built-in flash (p. 70).
Metering mode	Changes the metering pattern (p. 72).
Filter	Changes the overall color of an image (p. 73).
Color Saturation	Changes the color saturation of an image (p. 74).
Contrast Compensation	Changes the contrast of an image (p. 74).

CAMERA SENSITIVITY - ISO



Five settings can be selected for camera sensitivity: Auto, 50, 100, 200, 400, and 800; the numerical values are based on an ISO equivalent. ISO is the standard used to indicate film sensitivity: the higher the number, the more sensitive the film.

Camera sensitivity is selected with the function button and the controller (p. 64).

The auto setting automatically adjusts the camera sensitivity to the light conditions between ISO 50 and 200. When any other setting than auto is used, “ISO” and the set value is displayed on the monitors.

Photographers can select a specific sensitivity setting. Like grain in silver-halide film that increases with speed, noise increases with sensitivity in digital imaging; an ISO setting of 50 will have the least noise and 800 will have the most.

A change in ISO also affects the flash and shutter-speed range. See the next page for more on the flash range, and page 55 for the shutter-speed range.

As the ISO value doubles, the camera sensitivity doubles; changing the ISO between 100 and 200, 200 and 400, or 400 and 800 changes the camera sensitivity by one stop or 1 Ev (p. 105). A change between 100 and 800 changes the camera sensitivity by a factor of 8 or three stops. High ISO settings (400, 800) can allow the photographer to hand hold the camera in low-light conditions without the need of a flash.



Manual camera sensitivity indicator

FLASH RANGE AND CAMERA SENSITIVITY

For correct flash exposures, the subject must be within the flash range. The flash range can be extended by changing the camera sensitivity. When the camera sensitivity is set to auto, the ISO is set between ISO 50 and 200.

The flash range is measured from the CCD. Because of the optical system, the flash range is not the same at the lens' wide-angle position as it is at the telephoto position.

ISO setting	Flash range (wide angle)	Flash range (telephoto)
50	0.5m ~ 1.9m / 1.6 ft. ~ 6.2 ft.	0.5m ~ 1.5m / 1.6 ft. ~ 4.9 ft.
100	0.5m ~ 2.7m / 1.6 ft. ~ 8.9 ft.	0.5m ~ 2.1m / 1.6 ft. ~ 6.9 ft.
200 /AUTO	0.5m ~ 3.8m / 1.6 ft. ~ 12.5 ft.	0.5m ~ 3.0m / 1.6 ft. ~ 9.8 ft.
400	0.5m ~ 5.4m / 1.6 ft. ~ 17.7 ft.	0.5m ~ 4.2m / 1.6 ft. ~ 13.8 ft.
800	0.5m ~ 7.6m / 1.6 ft. ~ 24.9 ft.	0.5m ~ 6.0m / 1.6 ft. ~ 19.7 ft.

ATTACHING AN ACCESSORY FLASH UNIT

To extend the versatility of the camera, an accessory flash unit (sold separately) can be used. Always remove the accessory flash when the camera is not in use, and replace the accessory-shoe cap to protect the contacts.

Slide the accessory-shoe cap off as shown. Mount the flash unit on the accessory shoe by sliding it forward until it stops.

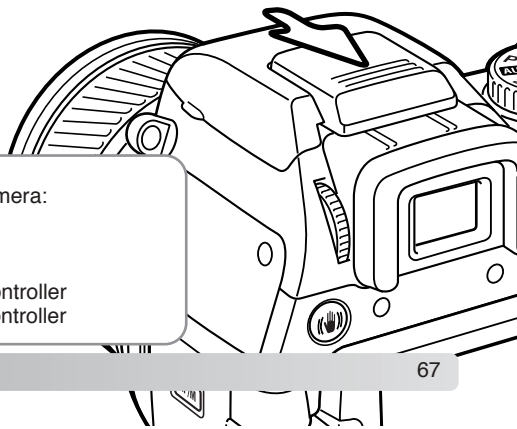

System Accessories

The following flash units are compatible with this camera:

Maxxum/Program Flash 2500(D)

Maxxum/Program Flash 3600HS(D)

Maxxum/Program Flash 5600HS(D)

Macro Ring Flash 1200 with Macro Flash Controller

Macro Twin Flash 2400 with Macro Flash Controller

COLOR MODE



The color mode controls whether a still image is color or black and white as well as the color space. This must be set before the image is recorded. Color mode is selected with the function button and the controller (p. 64). The live image on the monitors reflect the selected color mode. The color mode has no effect on image file size.



Vivid Color - increases the saturation of the colors in the scene. The increased saturation affects the RAW image data. Employs the sRGB color space. See the color example on page 2.



Natural Color - reproduces the colors in the scene faithfully. This mode uses no monitor indicator when active. Employs the sRGB color space. See the color example on page 2.



Portrait - optimizes color for portraiture. Employs the sRGB color space.



Embedded Adobe RGB - like Natural Color, this color mode reproduces the colors in the scene faithfully, but uses the extended gamut of the Adobe RGB color space. The color space is embedded in the image file. See the color example on page 2.



Black & White - produces monochrome images. Images can be toned using the Filter setting (p. 73). See the color example on page 2.

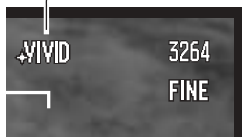

When a color mode other than the natural color is set, an indicator is displayed on the monitors.

ABOUT ADOBE RGB

Embedded Adobe RGB employs the Adobe RGB color space. Adobe RGB has a larger color gamut than the more common sRGB. The size of the gamut limits the colors that can be reproduced; the larger the gamut, the more colors. If the image will be printed out with a high-quality printer, the use of the Adobe RGB color mode is recommended over the sRGB color modes of Natural Color, Vivid Color, or Portrait.

Adobe RGB embeds an ICC profile in JPEG image data. Color matching must be used when opening Adobe-RGB image files. When using the DiMAGE Viewer, the color matching function must be active and the color space set to Original Color Space (Adobe RGB) in the color preferences window, see color matching in the advanced setup section in the DiMAGE Viewer manual. DiMAGE Viewer version 2.2 or later is required to open embedded Adobe RGB images taken with this camera.

Embedded Adobe RGB color mode cannot be used with RAW images.

Camera Notes

The control dial and the shift button can be used to set functions instead of the controller. Press and hold the shift button and turn the control dial to move the cursor vertically in the selection screen. Turn the control dial to move the cursor horizontally.



FLASH MODES

Flash mode is selected with the function button and the controller (p. 64). For the flash to fire, the built-in unit must be manually lifted. The flash fires in the selected mode regardless of the amount of ambient light. The auto-white-balance setting gives priority to the flash's color temperature. If preset or custom white-balance settings are used, priority is given to the active setting's color temperature.



The active flash mode is shown by an indicator on the monitors when the flash is lifted.

FILL FLASH

Fill-flash can be used as the main or supplementary light. In low-light conditions, the flash will act as the main source of illumination and overpower the ambient light. Under strong sunlight or in backlit situations, the fill-flash can reduce harsh shadows.



FILL-FLASH WITH RED-EYE REDUCTION

Fill-flash with red-eye reduction is used when taking photographs of people or animals in low-light conditions. The red-eye effect is caused by light reflected from the retina of the eye. The camera will fire two pre-flashes before the main flash burst to contract the pupils of the subject's eyes.



SLOW SHUTTER SYNC. WITH RED-EYE REDUCTION

With slow shutter sync, the flash and ambient light exposures are balanced; red-eye reduction is used. Use slow shutter sync. to reveal background details in dark locations. Ask your subject not to move after the flash burst; the shutter may still be open for the background exposure. Because exposures can be long, the use of a tripod is recommended.



REAR FLASH SYNC

Rear flash sync is used with long exposures to make trailing lights or blurring appear to follow rather than precede the subject. The effect is not apparent if the shutter speed is too fast and stops the subject's motion.



When the shutter is released, a pre-flash will fire. This pre-flash does not exposure the subject, but is used in the calculation of the flash exposure. The flash will fire again just before the shutter closes.

Camera Notes

Slow shutter sync can also be set using the AE lock button in P and A exposure modes.

With the subject in the AF area, press and hold the AE lock button to lock the exposure. Press the shutter-release button partway down to lock the focus. Compose the image on the monitor, then press the shutter-release button all the way down to take the picture. The operation of the AE lock button can be changed in section 1 of the recording menu.

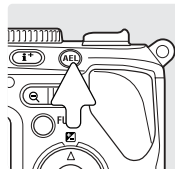

METERING MODES

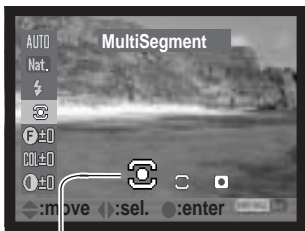

Metering modes changes the metering pattern. If the luminance levels of the scene are outside the metering range, the metering indicator turns red.

Metering mode is selected with the function button and the controller (p. 64).



Multi-segment - uses 256 segments to measure luminance and color. This data is combined with distance information to calculate the camera exposure. This advanced metering system will give accurate worry-free exposures in almost all situations.



Center weighted - a traditional metering method in film cameras. The system measures light values over the entire image area with emphasis given the center region.



Spot - uses a small area within the image to calculate the exposure. When this mode is selected, a small circle will appear in the middle of the live image indicating the measuring area. The spot allows precise exposure measurements of a particular object without being influenced by extremely bright or dark areas within the scene. When using spot metering with the Flex Focus Point (p. 48), the spot circle can move with the focus point. This function is selected in section 1 of the recording menu (p. 90).

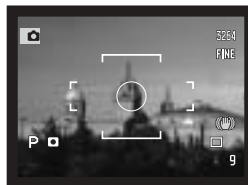

Spot metering display



When the metering mode is set, an indicator appears on the monitors.

FILTER



The overall color of a scene can be adjusted. The Filter effects differ between the color mode in use, see the color examples on page 171. The Filter effects are set with the function button and the controller (p. 64). When changing the setting, an icon and numeral will indicate the filter in effect.

If the Filter is set to any other setting than zero, an indicator and value will remain on the displays as a warning.



When used with Natural Color, Vivid Color, Portrait, or Embedded Adobe RGB, the Filter can be adjusted in eleven levels (± 5). A positive adjustment acts like a warming filter. A negative adjustment makes the image cooler.

When used with the black-and-white color mode, the Filter can tone the neutral monochrome image in eleven steps. The Filter effect cycles from neutral to red, to green, to magenta, to blue, and returning to neutral. The zero position is neutral. Black and white filter settings have no effect on RAW images.

COLOR-SATURATION COMPENSATION

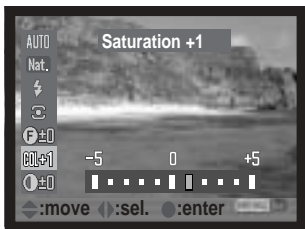

The color saturation of a scene can be adjusted within eleven levels (± 5). Colors can be accented, positive value, or subdued, negative value. Color saturation is set with the function button and the controller (p. 64).

When set to any value other than zero, an indicator and value will be displayed on the monitors as a warning.



CONTRAST COMPENSATION

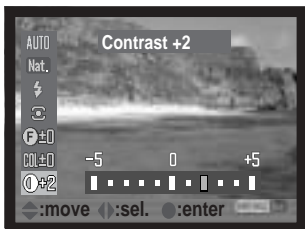

The contrast of a scene can be adjusted within eleven levels (± 5). Contrast can be increased, positive value, or decreased, negative value. Contrast is set with the function button and the controller (p. 64).

If contrast is set to any other value than zero, the indicator and value remain on the displays as a warning.



Contrast decreased



Contrast normal



Contrast increased

Camera Notes

Multiple settings can be made on the function-setting screen or exposure/flash compensation screen. Simply use the up/down keys to move to other functions before pressing the central button to complete the operation.

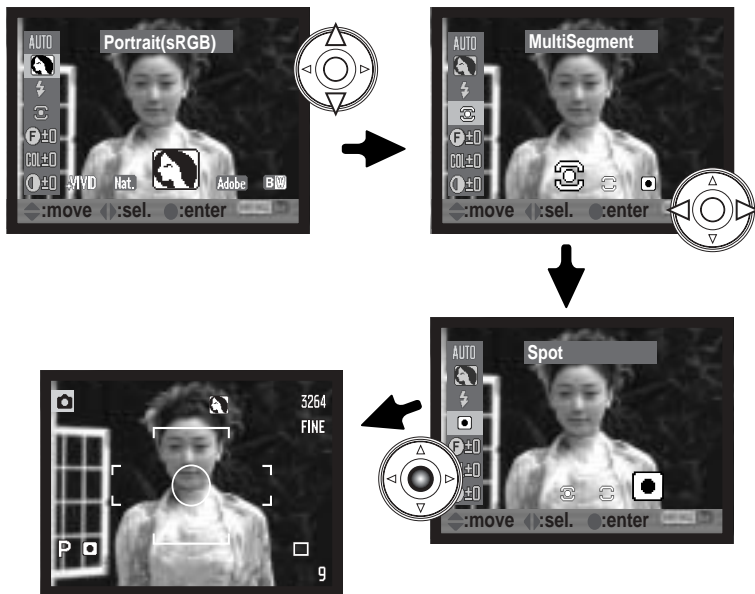

USING THE DRIVE-MODE BUTTON



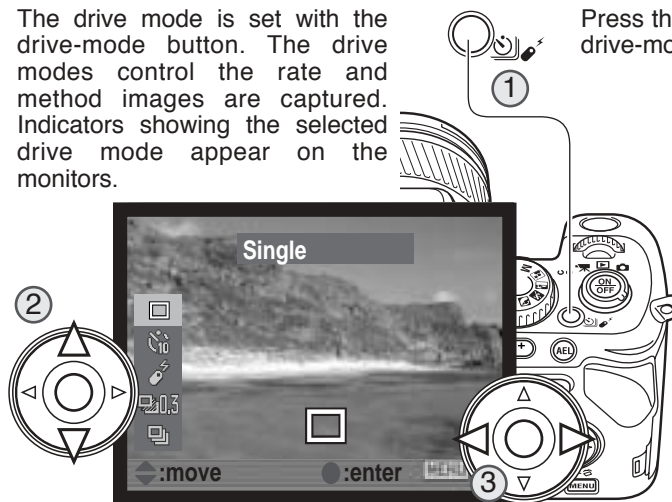

The drive mode is set with the drive-mode button. The drive modes control the rate and method images are captured. Indicators showing the selected drive mode appear on the monitors.

Press the drive-mode button (1); the drive-mode setting screen appears.



Use the up/down keys of the controller to highlight the the new drive mode (2). Use the left/right keys to select the drive mode options (3). Press the center of the controller or press shutter-release button partway down to complete the operation. Pressing the menu button cancels the operation.

Also see the camera notes on page 69.

	Single-frame advance	To take a single image each time the shutter-release button is pressed (p. 30).
	Self-timer	To delay the release of the shutter by 2 or 10 seconds. Used for self-portraits (p. 77).
	Remote control	To operate the camera with the remote control unit (p. 78).
	Bracketing	To take a series of three images with differing exposure, or white balance (p. 80).
	Continuous advance	To take a series of three images when the shutter-release button is pressed and held (p. 82).

SELF-TIMER

Used for self-portraits, the self-timer will delay the release of the shutter after the shutter button is pressed. A ten second and two second self-timer is available.



Self-timer is set with the drive-mode button and the controller (p. 76).



Two-second self-timer

Ten-second self-timer



When the self-timer is set, the indicator appears on the monitors.

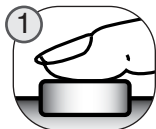

With the camera on a tripod, compose the picture as described in the basic recording section (p. 30). Focus lock (p. 32), spot AF area (p. 47) or the Flex Focus Point (p. 48) can be used with off-center subjects. Press the shutter-release button partway down (1) to lock the exposure and focus. Press the shutter-release button all the way down (2) to begin the countdown. Because focus and exposure are determined when the shutter-release button is pressed, do not stand in front of the camera when taking a self-timer image. Always confirm the focus with the focus signals before beginning the countdown (p. 33).

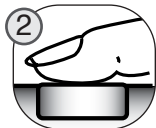

The self-timer lamp on the front of the camera and the audio signals indicate the countdown. The lamp will glow steadily just before the shutter fires. To stop the countdown, press the menu button or change the position of the flash (lift it or push it down). When using the ten-second self-timer, the drive mode is reset to single-frame advance after the exposure. The audio signal can be turned off in section 3 of the setup menu (p. 140).

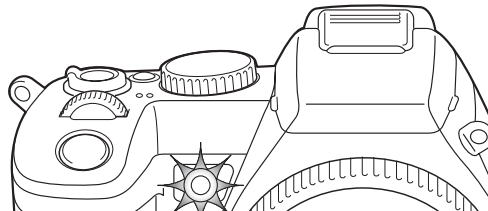

RECORDING WITH REMOTE CONTROL

The camera can be operated up to approximately 4m (13.1 ft.) away with the Wireless Remote Control RC-D1 supplied with the camera. This section covers how to setup the camera for remote control and recording operation for still and movie images. See page 126 for playback operation, and page 127 on how to replace the battery.

Setting up the camera for remote control

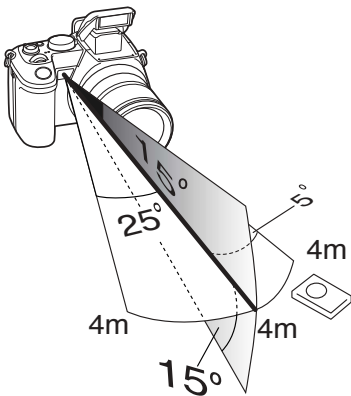

The remote control should be operated within the range shown. The remote control signal can be blocked if the zoom lens is extended, or an accessory such as the lens hood, or a wide-angle or telephoto converter is attached. Backlight, and fluorescent or bright lighting may prevent the remote control from working.

The self-timer lamp blinks to indicate the camera has received a signal from the remote control unit.

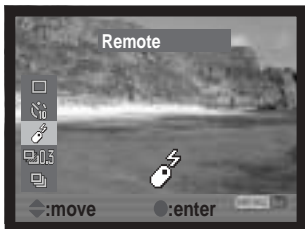

To record still images, set the mode switch to the recording position and select the remote control drive mode with the drive-mode button (p. 76).

To record movies, set the mode switch on the camera to movie recording position.

The remote control mode remains active after the picture is taken. To cancel it, select another drive mode.

When the remote-control drive mode is set, the indicator appears on the monitors.



Using the remote control

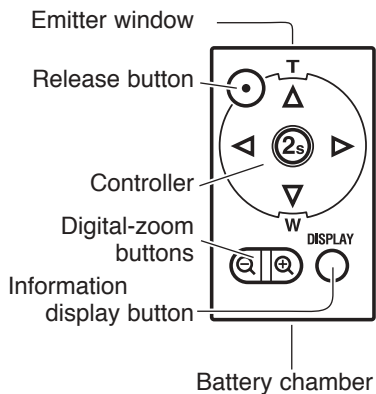

With the camera on a tripod, position the subject within the focus frame.

Point the remote control's emitter window toward the camera's self-timer lamp/remote-control receiver.

Pressing the information display button changes the display format, see page 43.

Digital zoom (p. 102) is activated by the digital-zoom buttons.

Press the release button or the center (2s) button of the controller to take the picture. The central button delays the release of the shutter for approximately two seconds; the self-timer lamp and the audio signal indicates the countdown. The self-timer lamp glows steadily just before the shutter releases. The release button fires the shutter without a delay. If the flash is used, the shutter is released after the flash has charged.

The focus and exposure are set when the release button or the central button of the controller is pressed.

When recording movies or bulb exposures, pressing the release button or the central button of the controller once starts the exposure; pressing the button a second time ends it.

BRACKETING

This drive mode makes a three image bracket of a scene. Bracketing is a method of taking a series of images of a static subject in which each image has a slight variation in exposure or white balance.



Bracketing mode is set with the drive-mode button and the controller (p. 76).

Exposure bracket - the order of the exposure bracket series is normal exposure (as indicated by the camera), underexposure, and overexposure. The exposure bracket increment can be selected between 0.3Ev and 0.5Ev. If the memory card is filled or the shutter button is released before the series has completed, the camera will reset and the entire bracket must be made again.

White-balance bracket - the bracket series is the current setting, cooler, and warmer. The bracket is smaller with WB bracket(L)/WB1 than with WB bracket(H)/WB2. See the white balance section on page 60.

Compose the picture as described in the basic recording section (p. 30).

To make an exposure bracket, press and hold the shutter-release button all the way down (1); three consecutive images are captured.

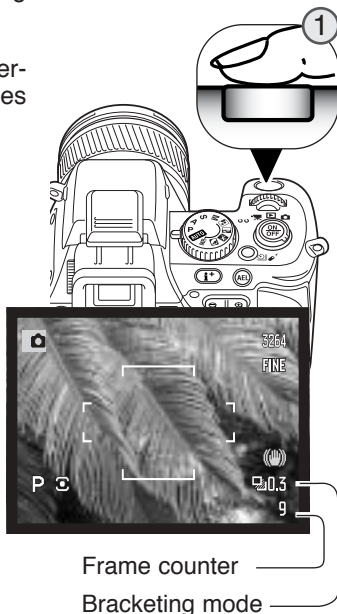
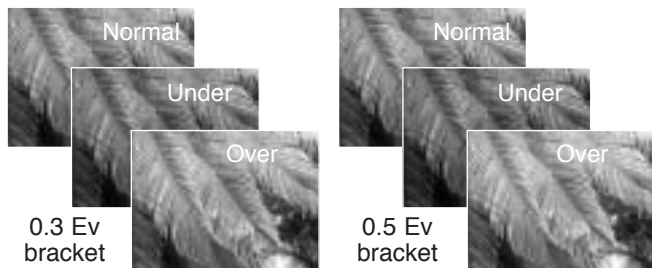

To make a white-balance bracket, press and release the shutter button. Three consecutive images are made from a single exposure.

The bracketing drive mode indicator is displayed when set. The remaining number of frames in the series is displayed next to the indicator during the bracket.

To make a flash bracket, raise the camera flash; the ambient exposure is not bracketed. When using flash, single-frame advance is employed and the shutter-release button must be pressed for each exposure.

When exposure brackets are made in S exposure mode, the aperture controls the bracket. In A and M modes, the shutter speed controls the bracket; in M mode, pressing the AE lock button during the bracket changes the exposure control to the aperture.

CONTINUOUS ADVANCE

Continuous-advance mode allows a series of images to be captured while holding down the shutter-release button. Continuous advance acts like a motor drive on a film camera. RAW & JPEG image quality cannot be used. RAW cannot be used with UHS continuous advance.



Continuous-advance mode is set using the drive-mode button and the controller (p. 76).



Continuous advance - captures a maximum of five images at 2 fps. When used with continuous autofocus, the camera adjusts the focus during the series. The live image is briefly displayed between frames.



High-speed continuous advance - captures a maximum of five full-size images at 2.3fps. Focus is locked with the first frame regardless of the focusing mode. The monitor turns off during the series.



UHS continuous advance - captures forty 640 X 480 size images at 10fps regardless of the image-quality setting. Focus is locked with the first frame regardless of the focusing mode. The digital zoom and flash cannot be used. Shutter speeds must be 1/30 second or faster. Very bright light sources within the image may cause streaking. Black areas caused by a loss of data may be apparent. When the red low-battery warning is displayed, this drive mode cannot be used.

When a continuous-advance drive mode is set, an indicator appears on the monitors.



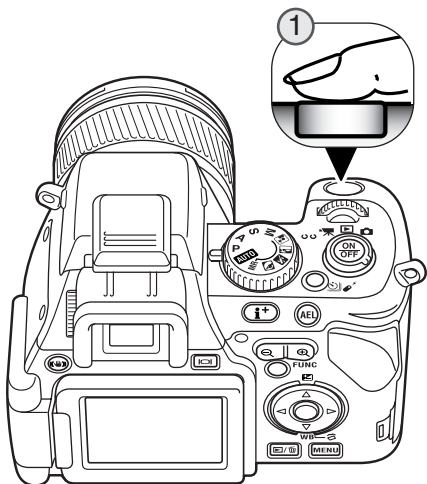

Compose the picture as described in the basic recording section (p. 30). Press and hold the shutter-release button all the way down (1) to begin taking pictures. The camera continues to record images until the maximum number has been taken or the shutter button is released.

The built-in flash can be used with standard and high-speed continuous advance, but the rate of capture is reduced because the flash must recharge between frames.

Camera Notes

When a large amount of image data is captured in a short period, the camera's internal buffer memory becomes full; the frame counter turns yellow on the monitors. Time must be given for this data to be written to the memory card. Wait for the indicator to turn white before capturing more images.

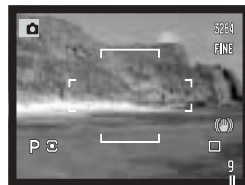

RECORDING MENU

In recording mode, press the menu button to activate the menu. The menu button also closes the menu after making settings. The four-way key of the controller is used to move the cursor in the menu. Pressing the central button of the controller will enter a setting.

NAVIGATING THE RECORDING MENU

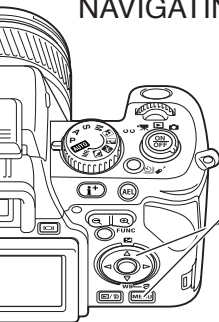

MENU

Activate the recording menu with the menu button. Tab 1 at the top of the menu will be highlighted.



Use the left/right keys of the controller to highlight the appropriate menu tab; the menus will change as the tabs are highlighted.



When the desired menu section is displayed, use the up/down key to scroll through the menu options. Highlight the option whose setting needs to be changed.



Press the right controller key to display the settings; the current setting is indicated by an arrow. To return to the menu options, press the left key.



Use the up/down keys to highlight the new setting. If “Enter” is displayed, press the central button of the controller to open the next screen.



Press the central button of the controller to select the highlighted setting.

Once a setting has been selected, the cursor will return to the menu options and the new setting will be displayed. Changes can continue to be made. To return to the recording mode, press the menu button.

Image size	3264x2448
Quality	Fine
Spot AE area	Center spot
Flash control	Auto
AEL button	AE hold
Reset	-

- To set image resolution (p. 86).
- To set file type and compression (p. 86).
- To select the spot metering area location with FFP (p. 90).
- To set automatic or manual flash control (p. 90).
- To customize the operation of the AEL button (p. 92).
- To reset the recording-mode functions (p. 93).

Sharpness	Normal
Date imprint	Off
Inst.Playback	Off
Full-time AF	Off
Direct MF	Off

- To increase or decrease image sharpness (p. 94).
- To imprint date or time on a recorded image (p. 95).
- To play back images after they are recorded (p. 96).
- To activate full-time AF (p. 97).
- To activate Direct Manual Focus (p. 97).

Memory	-
DSP set	DSP
Noise reductn	On
Monitor amp.	Auto
Manual exp.	Exp. priority
Digital zoom	Off

- To save camera settings (p. 98).
- To use Digital Subject Programs for memory recall (p. 100).
- To apply noise reduction to long exposures (p. 100).
- To activate automatic monitor amplification (p. 101).
- To set M exposure mode monitor preferences (p. 101).
- To set the digital zoom (p. 102).

IMAGE SIZE AND IMAGE QUALITY

Image size and quality are set in section 1 of the recording menu (p. 84). Changes are displayed in the top right corner of the monitors.

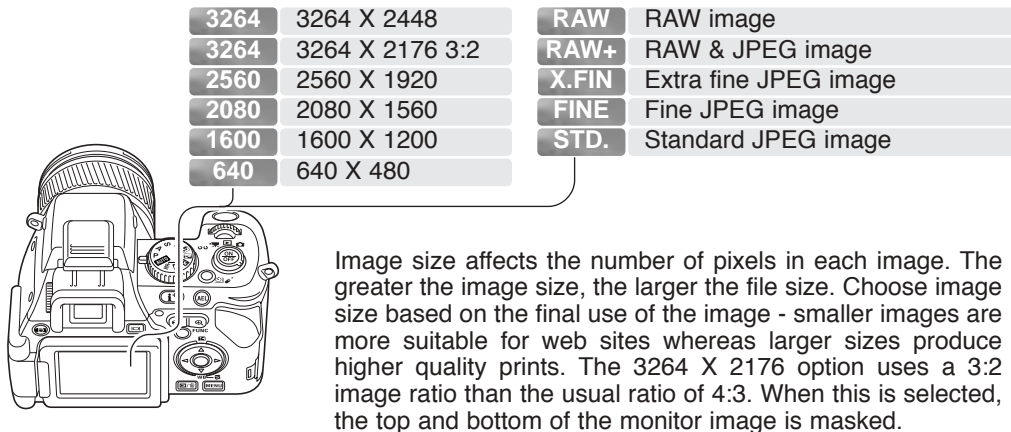

3264	3264 X 2448	RAW	RAW image
3264	3264 X 2176 3:2	RAW+	RAW & JPEG image
2560	2560 X 1920	X.FIN	Extra fine JPEG image
2080	2080 X 1560	FINE	Fine JPEG image
1600	1600 X 1200	STD.	Standard JPEG image
640	640 X 480		

Image size affects the number of pixels in each image. The greater the image size, the larger the file size. Choose image size based on the final use of the image - smaller images are more suitable for web sites whereas larger sizes produce higher quality prints. The 3264 X 2176 option uses a 3:2 image ratio than the usual ratio of 4:3. When this is selected, the top and bottom of the monitor image is masked.

Image quality controls the file type and rate of compression. RAW is a high-quality image file. The extra fine, fine, and standard settings produce JPEG files at various rates of compression. The higher the image quality, the lower the rate of compression and the larger the file sizes. If economical use of the memory card is important, use the standard mode. The RAW & JPEG option creates two image files at one time, a 3264 X 2448 RAW file and a fine quality JPEG file with an image size selected with the menu. The image files are saved with the same file name, but with different extensions (p. 148). It can require more than 10 seconds to save RAW files; the frame counter turns yellow and no images can be captured during this period.

Only full-size images can be taken with RAW image quality. RAW images require special processing before they can be used, refer to the DiMAGE Viewer software manual. Some camera functions cannot be used with the RAW image-quality setting. See page 88 for more information.